

Operating Instructions

GRAPHIC EQUALIZER GR-777

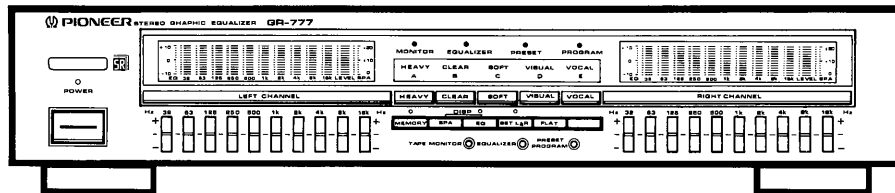

Thank you for buying this PIONEER product. Please read through these operating instructions so you will know how to operate your model properly. After you have finished reading the instructions, put them away in a safe place for future reference.

In some countries or regions, the shape of the power plug and power outlet may sometimes differ from that shown in the explanatory drawings. However, the method of connecting and operating the unit is the same.

WARNING: TO PREVENT FIRE OR SHOCK HAZARD. DO NOT EXPOSE THIS APPLIANCE TO RAIN OR MOISTURE.

IMPORTANT NOTICE
[For U.S. and Canadian models]

The serial number for this equipment is located on the rear panel. Please write this serial number on your enclosed warranty card and keep it in a secure are. This is for your security.

[For Canadian model]

CAUTION: TO PREVENT ELECTRIC SHOCK DO NOT USE THIS (POLARIZED) PLUG WITH AN EXTENSION CORD, RECEPTACLE OR OTHER OUTLET UNLESS THE BLADES CAN BE FULLY INSERTED TO PREVENT BLADE EXPOSURE.

ATTENTION: POUR PREVENIR LES CHOCS ELECTRIQUES NE PAS UTILISER CETTE FICHE POLARISEE AVEC UN PROLONGATEUR UNE PRISE DE COURANT OU UNE AUTRE SORTIE DE COURANT, SAUF SI LES LAMES PEUVENT ETRE INSEREES A FOND SANS EN LAISSER AUCUNE PARTIE A DECOUVERT.

LINE VOLTAGE SELECTOR SWITCH

Only multi-voltage models are provided with these switches. U.S., Canadian, European, U.K., and Australian models are not provided with this switch. Mains voltages in Saudi Arabia are 127 V and 220 V only. Never use this model with 110 V settings in Saudi Arabia.

The line voltage selector switch is on the rear panel. Before your model is shipped from the factory, this switch is set to the power requirements of the destination. Check that it is set properly before plugging the power cord into the AC outlet. If the voltage is not properly set or if you move to an area where the voltage requirements differ, adjust the selector switch as follows.

Use a medium-sized (flat-blade) screwdriver. Insert the tip of the screwdriver into the groove of the selector switch and turn is so that the power voltage marking of your area points to the arrow.

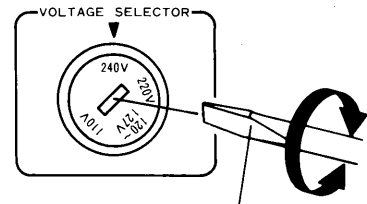

Medium-size screwdriver

CONTENTS

Put Batteries into Remote Control Unit	7	Using the Equalizer Controls	11
Connexions.....	8	Troubleshooting	12
Panel and Remote Control Unit Facilities	8	Switch Function Diagram	12
Operation	10	Specifications	12

IMPORTANT 1



The lightning flash with arrowhead, within an equilateral triangle, is intended to alert the user of the presence of uninsulated "dangerous voltage" within the product's enclosure that may be of sufficient magnitude to constitute a risk of electric shock to persons.



CAUTION:
TO PREVENT THE RISK OF ELECTRIC SHOCK, DO NOT REMOVE COVER (OR BACK). NO USER-SERVICEABLE PARTS INSIDE. REFER SERVICING TO QUALIFIED SERVICE PERSONNEL.



The exclamation point within an equilateral triangle is intended to alert the user of the presence of important operating and maintenance (servicing) instructions in the literature accompanying the appliance.

SAFETY INSTRUCTIONS

READ INSTRUCTIONS—All the safety and operating instructions should be read before the appliance is operated.

RETAIN INSTRUCTIONS—The operating instructions should be retained for future reference.

HEED WARNING—All warnings on the appliance and in the operating instructions should be adhered to.

FOLLOW INSTRUCTIONS—All operating and use instructions should be followed.

WATER AND MOISTURE—The appliance should not be used near water — for example, near a bathtub, washbowl, kitchen sink, laundry tub, in a wet basement, or near a swimming pool, etc.

LOCATION—The appliance should be installed in a stable location.

WALL OR CEILING MOUNTING—The appliance should not be mounted to a wall or ceiling.

VENTILATION—The appliance should be situated so that its location or position does not interfere with its proper ventilation. For example, the appliance should not be situated on a bed, sofa, rug, or similar surface that may block the ventilation openings; or, placed in a built-in installation, such as a bookcase or cabinet that may impede the flow of air through the ventilation openings.

HEAT—The appliance should be situated away from heat sources such as radiators, heat registers, stoves, or other appliances (including amplifiers) that produce heat.

POWER SOURCES—The appliance should be connected to a power supply only of the type described in the operating instructions or as marked on the appliance.

POWER-CORD PROTECTION—Power-supply cords should be routed so that they are not likely to be walked on or pinched by items placed upon or against them, paying particular attention to cords at plugs, convenience receptacles, and the point where they exit from the appliance.

POLARIZATION—If your purchased product is provided with a polarized power plug, please read the following instructions. This product is equipped with a polarized alternating current line plug (a plug having one blade wider than the other). This plug will fit into the power outlet only one way. This is a safety feature. If you are unable to insert the plug fully into the outlet, try reversing the plug. If the plug should still fail to fit, contact your electrician to replace your obsolete outlet. Do not defeat the safety purpose of the polarized plug.

CLEANING—The appliance should be cleaned only with a polishing cloth or a soft dry cloth. Never clean with furniture wax, benzene, insecticides or other volatile liquids since they may corrode the cabinet.

POWER LINES—An outdoor antenna should be located away from power lines.

NONUSE PERIODS—The power cord of the appliance should be unplugged from the outlet when left unused for a long period of time.

OBJECT AND LIQUID ENTRY—Care should be taken so that objects do not fall and liquids are not spilled into the enclosure through openings.

DAMAGE REQUIRING SERVICE—The appliance should be serviced by a Pioneer authorized service center or qualified service personnel when:

- The power-supply cord or the plug has been damaged; or
- Objects have fallen, or liquid has been spilled into the appliance; or
- The appliance has been exposed to rain; or
- The appliance does not appear to operate normally or exhibits a marked change in performance; or
- The appliance has been dropped; or the enclosure damaged.

SERVICING—The user should not attempt to service the appliance beyond that described in the operating instructions. For all other servicing, contact the nearest Pioneer authorized service center.

OUTDOOR ANTENNA GROUNDING—If an outside antenna is connected to the antenna terminal, be sure the antenna system is grounded so as to provide some protection against voltage surges and built up static charges.

In the U.S.A. section 810 of the National Electrical Code, ANSI/NFPA No. 70-1984, provides information with respect to proper grounding of the mast and supporting structure, grounding of the lead-in wire to an antenna discharge unit, size of grounding conductors, location of antenna-discharge unit, connection to grounding electrodes, and requirements for the grounding electrode. See Fig. A.

- a) Use No. 10 AWG (5.3 mm²) copper, No. 8 AWG (8.4 mm²) aluminum, No. 17 AWG (1.0 mm²) copperclad steel, bronze wire, or larger as ground wire.
- b) Secure antenna lead-in and ground wires to house with stand-off insulators spaced from 4 feet (1.22 meters) to 6 feet (1.83 meters) apart.
- c) Mount antenna discharge unit as closely as possible to where lead-in enters house.
- d) Use jumper wire not smaller than No. 6 AWG (13.3 mm²) copper, or the equivalent, when a separate antenna-grounding electrode is used. See NEC Section 810-21 (j).

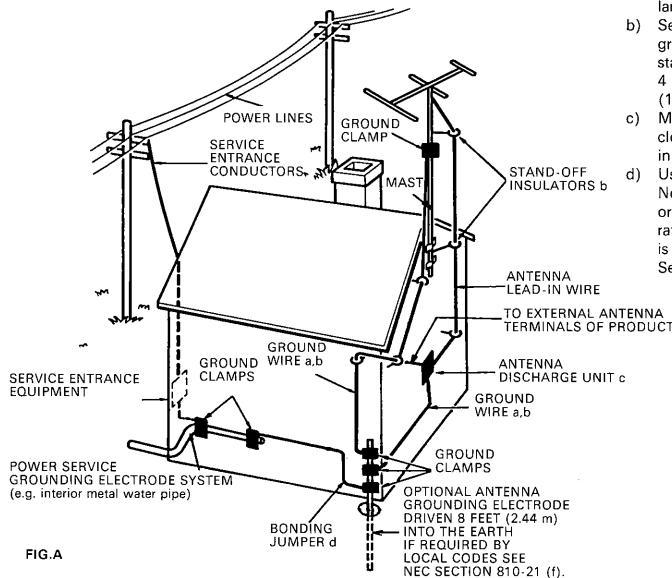

FIG. A

INFORMATION TO USER [FOR U.S. MODEL]

This equipment generates and uses radio frequency energy and if not installed and used properly, that is, in strict accordance with the manufacturer's instructions, may cause interference to radio and television reception. It has been type tested and found to comply with the limits for a Class B computing device in accordance with the specifications in Subpart J of Part 15 of FCC Rules, which are designed to provide reasonable protection against such interference in a residential installation. However, there is no guarantee that interference will not occur in a particular installation.

If this equipment does cause interference to radio or television reception, which can be determined by turning the equipment off and on, the user is encouraged to try to correct the interference by one or more of the following measures:

- reorient the receiving antenna
- relocate this equipment with respect to the receiver
- move this equipment away from the receiver
- plug this equipment into a different outlet so that equipment and receiver are on different branch circuits.

If necessary, the user should consult the dealer or an experienced radio/television technician for additional suggestions. The user may find the following booklet prepared by the Federal Communications Commission helpful:

"How to Identify and Resolve Radio-TV Interference Problems".

This booklet is available from the US Government Printing Office, Washington, D.C., 20402, Stock No. 004-000-00345-4.

The above instructions apply only to units which will be operated in the United States.

A

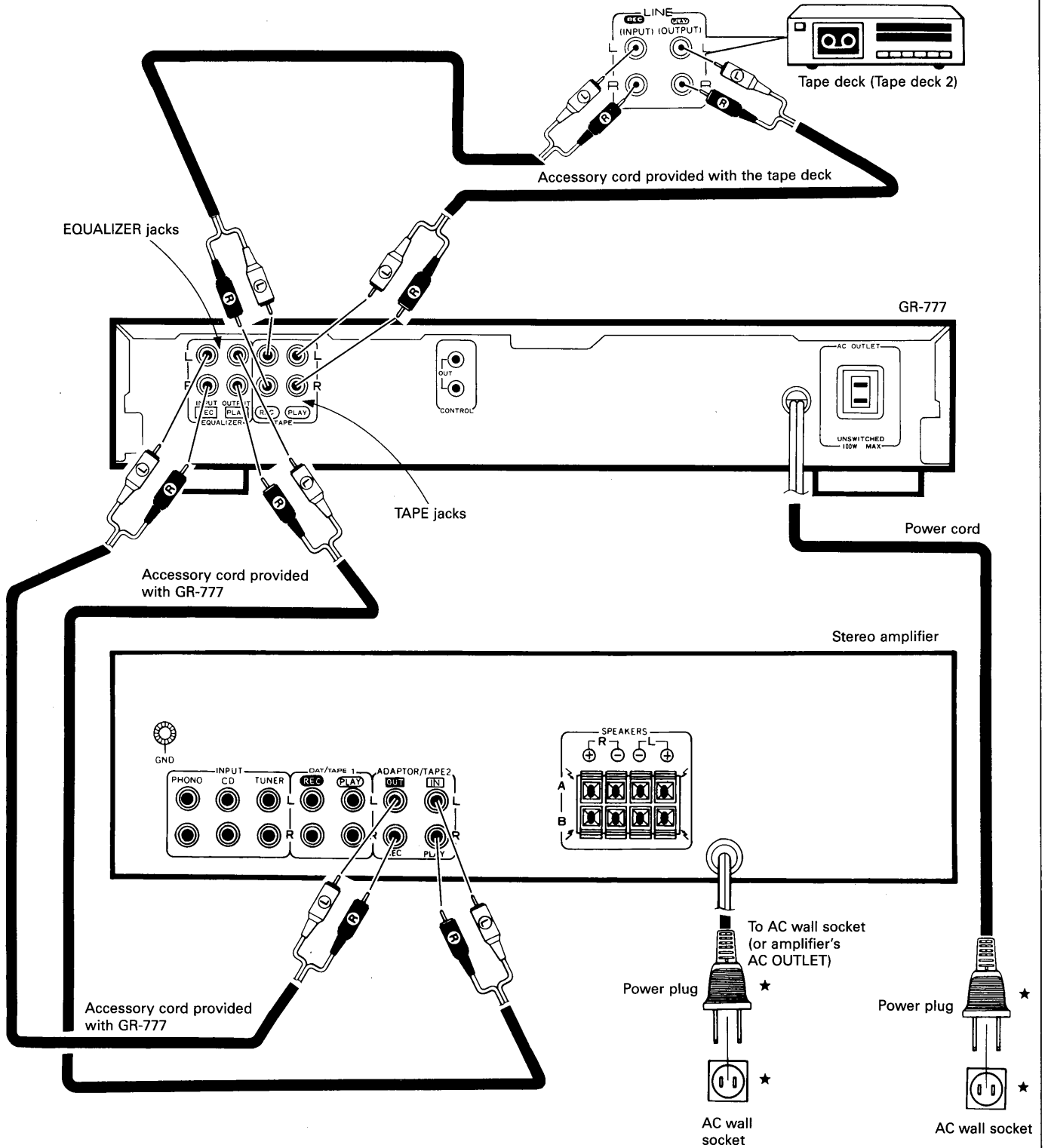

★ Illustration not applicable to U.K. model.

B

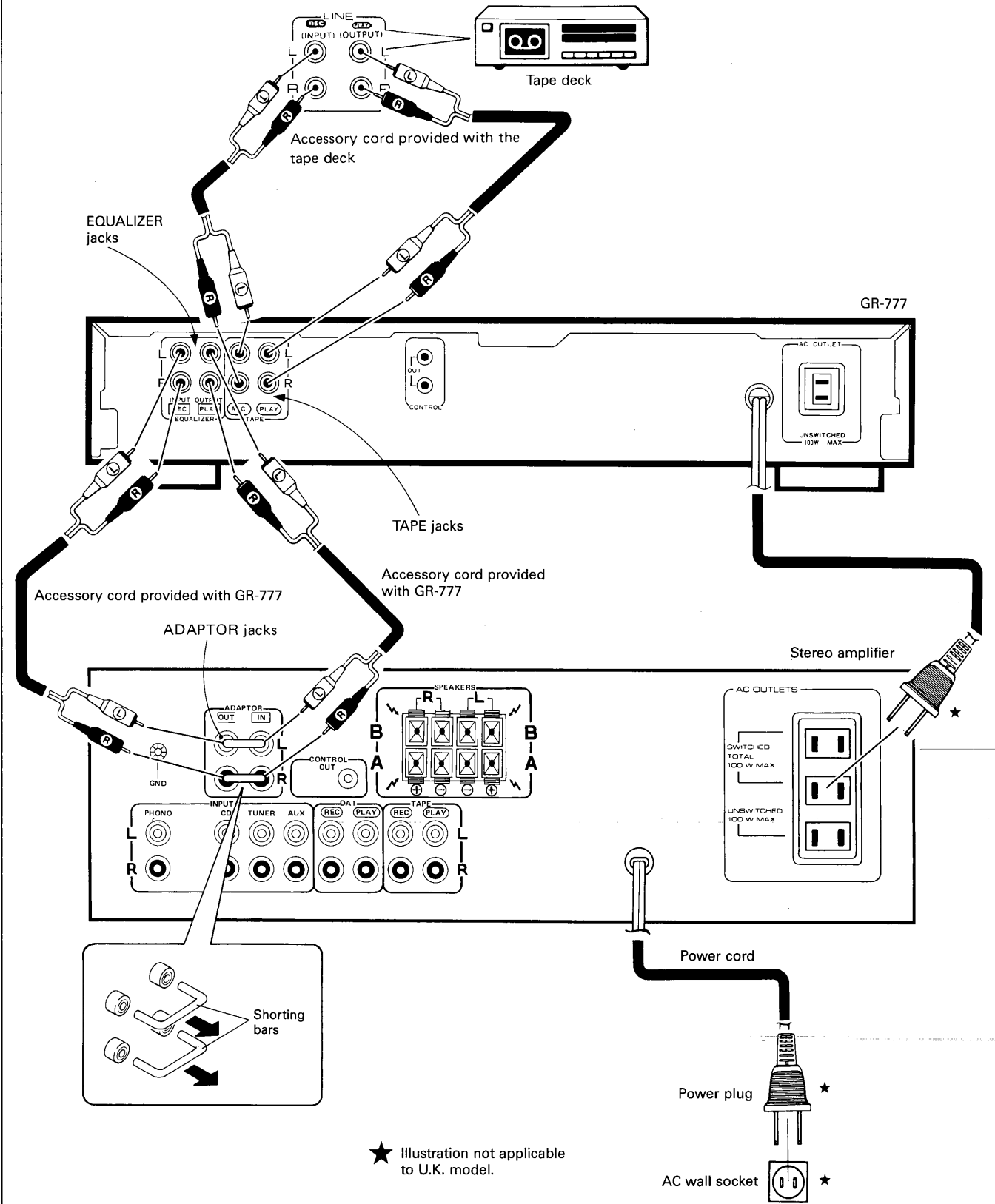

C

[REAR PANEL]

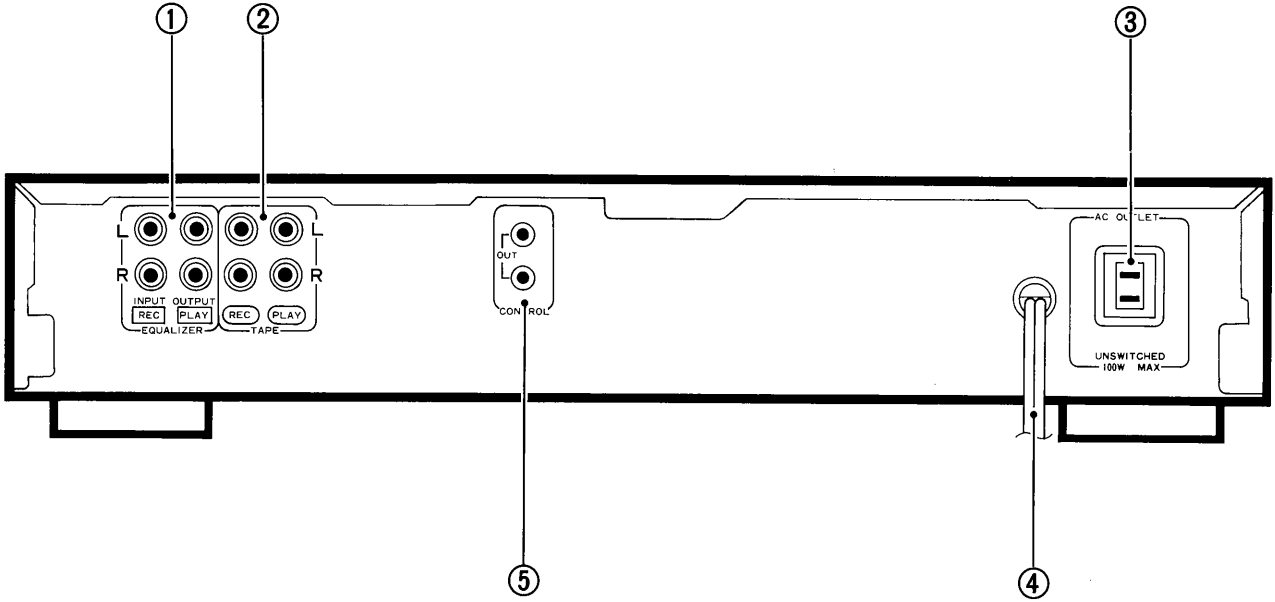

[FRONT PANEL]

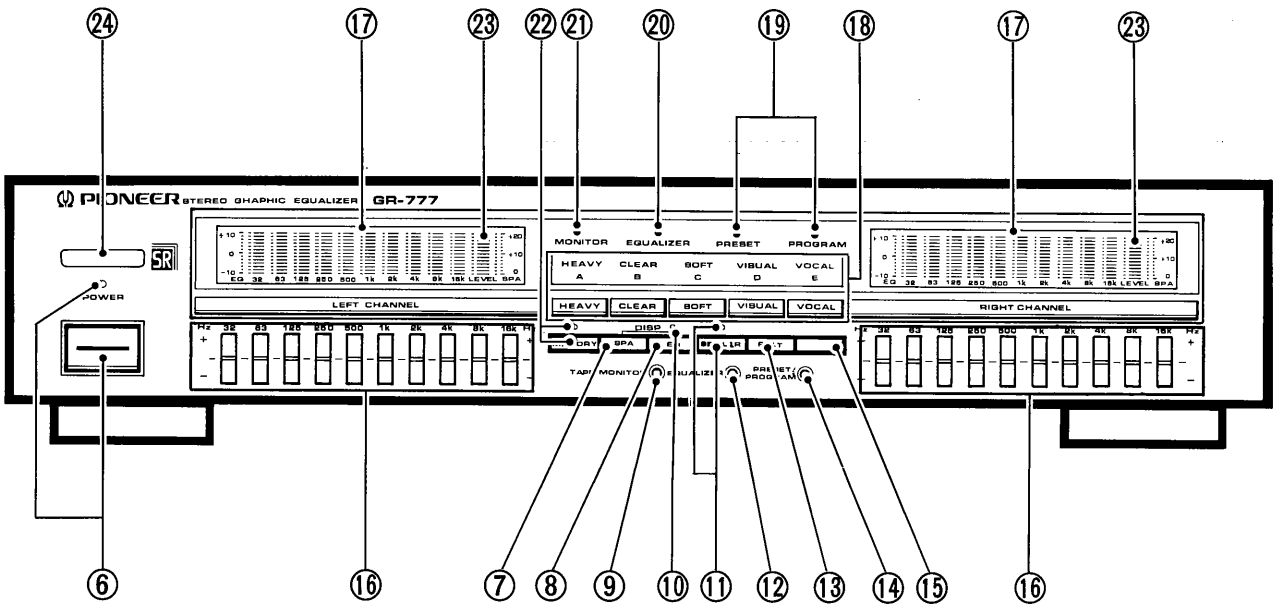

D

[REMOTE CONTROL UNIT]

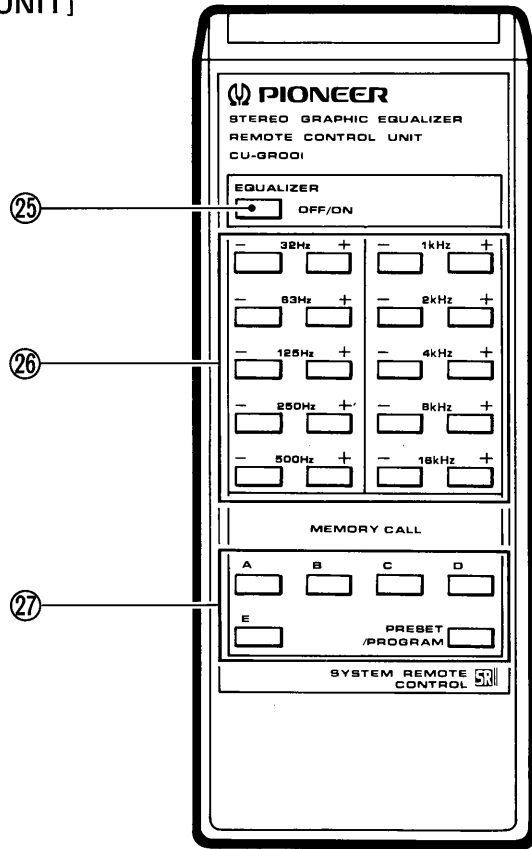

Range of remote control

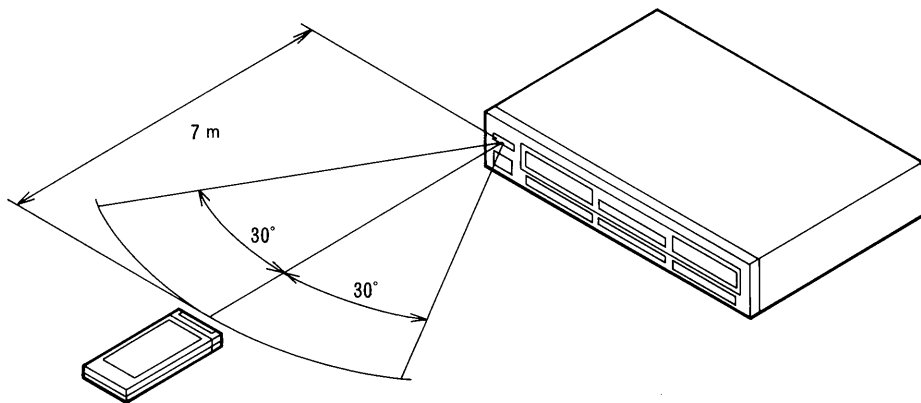

ACCESSORIES

Stereo connection cords x 2

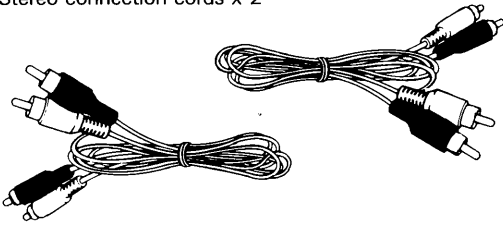

Remote control unit x 1

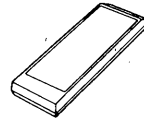

Batteries (R03/UM-4) x 2



PUT BATTERIES INTO REMOTE CONTROL UNIT

1. Open the rear cover.
2. Install batteries making sure that the + - polarity is correct.
3. Close the cover.

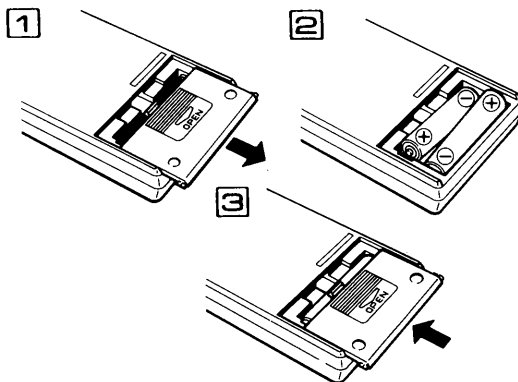

Cautions for handling dry batteries

Misusing dry batteries can result in electrolyte leakage or explosions. Bear in mind the following points for getting the most out of your batteries.

- When loading the batteries into the battery compartment, make sure the plus + and minus - polarities correspond to the marking on the compartment.
- Even though they may be the same shape, batteries come with different voltage ratings. Do not mix or use different types of batteries together. Use only the same kind of batteries.
- Do not mix up new batteries and used batteries but replace all the batteries at the same time.
- Do not heat up, disassemble or short-circuit batteries or throw them into a fire.
- Some batteries are rechargeable while others are not. Observe the cautionary notes on the batteries and use them properly.

CONNECTIONS—Refer to the illustration **A** on page 3 and **B** on page 4.

Turn off all power switches on all components before making connections.

The illustration shows connections for a typical system using Pioneer components. Refer to operating instructions of each unit for details.

Connect GR-777 EQUALIZER INPUT jacks to the stereo amplifier ADAPTOR OUT (or ADAPTOR/TAPE2 etc.) jacks.

Connect GR-777 EQUALIZER OUTPUT jacks to the stereo amplifier ADAPTOR IN (or ADAPTOR/TAPE2 etc.) jacks.

[Tape Deck Connections]

Connect the GR-777 TAPE REC jacks to the tape deck REC [INPUT] jacks.

Connect the GR-777 TAPE PLAY jacks to the tape deck PLAY [OUTPUT] jacks.

[Optional System Control Connections]

Pioneer components bearing the **SR** mark can be connected for extended remote control. Use a miniature phone plug cord to connect the component CONTROL IN terminal to the GR-777 CONTROL OUT terminal. The component remote control can then be operated pointing at the GR-777 remote sensor window.

PANEL AND REMOTE CONTROL UNIT FACILITIES—Refer to the illustration **C** on page 5 and **D** on page 6.

REAR PANEL FACILITIES

① EQUALIZER jacks

Connect these jacks to your amplifier tape or adaptor jacks.

② TAPE jacks

Connect a tape deck to these jacks.

③ AC OUTLET (UNSWITCHED 100W MAX)

Other units may be plugged into this outlet if total power consumption does not exceed 100 watts. Power is always available even if the equalizer is switched off.

Unplug the AC power cord from the wall socket when not using this unit regularly (when on vacation).

NOTE:

Do not use this outlet for connection of electric irons, heaters, TV sets, or other appliances that use much power. Malfunction of the equalizer and overheating or fire may result.

④ Power cord

Connect to auxiliary AC outlet on amplifier.

⑤ CONTROL OUT terminals

Connect to the control in terminals of other Pioneer components bearing the **SR** mark.

FRONT PANEL FACILITIES

⑥ POWER switch/indicator

Press once to turn on. Press again to turn off.

The indicator lights when power is turned on. The indicator flashes when receiving commands from the remote control unit.

Even when the power switch is off, the transformer remains connected to the AC power source. Unplug the AC power cord from the wall socket when not using this unit regularly.

⑦ SPA (spectrum analyzer) switch

Press to switch to spectrum analyzer display. Graphic equalizer display reappears for five seconds when a memory recall switch or control switch is pressed.

⑧ EQ (equalizer) switch

Press to switch to graphic equalizer display.

⑨ TAPE MONITOR switch

For listening to a tape deck connected to the rear panel TAPE jacks. During playback, press this switch so that the MONITOR indicator lights. Turn this switch off when listening to other music sources.

Do not press this switch after you begin recording; it may cause gaps in the sound.

⑩ EQ (Equalizer) indicator

Lights when the EQ switch is pressed.

11 SET L & R switch (and indicator)

When this switch is on, you can use the control switches of either channel to provide simultaneous adjustment of both channels. (The indicator lights when this is on.)

NOTE:

This does not make both sides have the same settings, it only lets you adjust the same frequency band on the left and right channels at the same time.

12 EQUALIZER switch

Turn this switch on to apply equalization to the sound. Turn it off when you do not want equalization.

13 FLAT switch

Press this switch to reset all frequency bands to their center "0" positions.

14 PRESET/PROGRAM switch

This selects PRESET or PROGRAM operation for the five "memory recall" switches, as confirmed by the PRESET and PROGRAM indicators.

(The five "memory recall" switches can be used to recall the factory preset curves or your own programmed curves.)

15 REV (Reverse) switch

This inverts the current equalization curve, so the boosted frequencies are reduced and the reduced frequencies boosted.

16 Control switches

Press the plus side to boost the level; press the minus side to reduce it.

NOTE:

Tweeters may be damaged if you boost the high frequencies excessively and then play music at high volume. Keep the amplifier volume at a suitable level when using equalization curves that emphasize the treble tones.

17 SPECTRUM ANALYZER/EQUALIZER display

When operating as a spectrum analyzer, this shows the effect of your equalization upon the actual output signal.

When operating as a graphic equalizer display, it shows the equalization curve.

18 Memory recall switches/indicators

There are five memory switches A through E. When the PRESET indicator is lit, these select the factory presets:

HEAVY: a powerful, heavy bass sound.

CLEAR: a bright, clear sound.

SOFT: a soft sound, free from harshness.

VISUAL: useful with video soundtracks and TV.

VOCAL: adds presence to vocals.

When the PROGRAM indicator is lit, these switches select the equalization curves that you have stored.

19 PRESET and PROGRAM indicators

These indicate whether you have selected the PRESET or the PROGRAM equalization curves.

20 EQUALIZER indicator

This lights when the EQUALIZER switch is on.

21 MONITOR indicator

This lights when the TAPE MONITOR switch is on.

22 MEMORY switch/indicator

Use when storing equalization curves in the memory recall switches (A-E) 18.

23 Level meter

Shows signal level.

24 REMOTE SENSOR window

Point top of remote control unit at this window during operation.

NOTE:

When making connections between CONTROL IN/OUT terminals for extended remote control, other components bearing the SR mark may be connected to the equalizer. However, the equalizer has only a CONTROL OUT terminal, so it should be at the end of the chain.

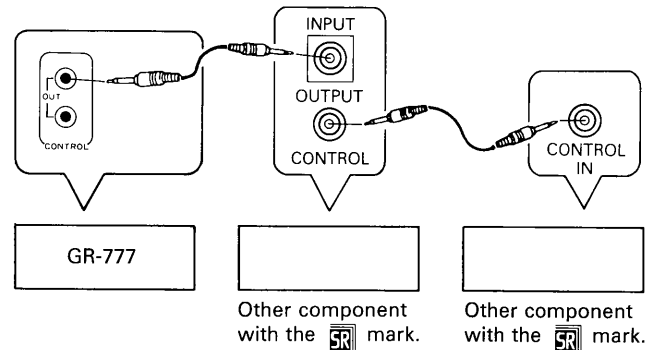

REMOTE CONTROL UNIT FACILITIES

25 EQUALIZER OFF/ON key

Same as front panel EQUALIZER switch.

26 Control keys

Same as equalizer control switches on front panel.

27 MEMORY CALL function keys

- **A – E keys:** same as memory recall switches on front panel.
- **PRESET/PROGRAM key:** same as front panel PRESET/PROGRAM switch.

Range of remote control

When the remote control unit is pointed at the remote control sensor window on the deck amplifier and any of its keys is pressed, the unit and other components can be operated by remote control.

Distance: Within a range of about 7 meters from the unit's remote control sensor window.

Angle: Within approx. 30 degrees from the center of the unit's remote control sensor window.

Remote control will not be possible if there is an obstacle between the remote control unit itself and the unit's remote sensor window.

OPERATION

TO PLAY RECORDS

1. Set amplifier input selector switch to PHONO.
2. Turn on EQUALIZER switch ⑫ on equalizer.
3. Play record.
4. Adjust equalizer controls ⑯.

TO RECORD BROADCASTS

Consult the amplifier operating instructions.

You can record on a tape deck connected to the equalizer or on a tape deck connected directly to the amplifier.

1. Select TUNER as the amplifier input.
2. Turn on EQUALIZER switch ⑫ on equalizer.
3. Tune in desired station.
4. Adjust equalizer controls ⑯.
5. Begin recording.

- Some amplifiers do not permit recording equalized sound on a deck connected to the amplifier TAPE 2 jacks.

TO PLAY TAPES

1. Select TAPE as the amplifier input.
2. If tape deck is connected directly to amplifier, turn off equalizer TAPE MONITOR switch ⑨.
If tape deck is connected to equalizer, turn on equalizer TAPE MONITOR switch ⑨.
3. Turn on EQUALIZER switch ⑫ on equalizer.
4. Play tape.
5. Adjust equalizer controls ⑯.

TO EDIT TAPES

Consult the amplifier operating instructions.

To transfer music from the tape deck connected to the amplifier to the tape deck connected to the equalizer:

1. Select TAPE 1 as the amplifier input.
2. Turn off equalizer TAPE MONITOR switch ⑨.
3. Turn on EQUALIZER switch ⑫ on equalizer.
4. Play tape in tape deck connected to amplifier.
5. Adjust equalizer controls ⑯.
6. Begin recording on tape deck connected to equalizer.

To transfer music from the tape deck connected to the equalizer to the tape deck connected to the amplifier:

1. Select any source except TAPE 1 as the amplifier input.
2. Turn on equalizer TAPE MONITOR switch ⑨.
3. Turn on EQUALIZER switch ⑫ on equalizer.
4. Play tape in deck connected to equalizer.
5. Adjust equalizer controls ⑯.
6. Begin recording on deck connected to amplifier.

USING THE MEMORY PRESET AND PROGRAM EFFECTS

There are five equalization presets: HEAVY, CLEAR, SOFT, VISUAL, and VOCAL. Five more equalization curve "programs" can be stored.

STORING EQUALIZATION CURVES IN MEMORY

1. Adjust the equalizer controls.

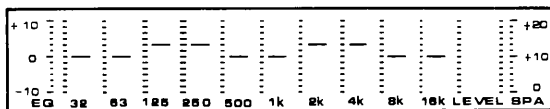

2. Press the MEMORY switch ⑳.
- The indicator will flash for about five seconds.



3. Press one of the memory recall switches ⑱ (A through E) before the indicator stops flashing.

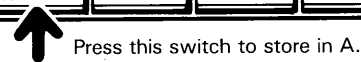
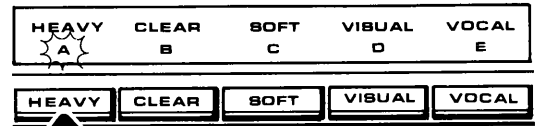

Press this switch to store in A.

Program memory may be erased if power is left off for about two weeks or more.

MEMORY RECALL

1. Press the PRESET/PROGRAM switch ⑭ to select the presets or your own programmed effects.
 - When the PRESET indicator is on, you can select any of the preset effects: HEAVY, CLEAR, SOFT, VISUAL, or VOCAL.
 - When the PROGRAM indicator is on, you can select any of the effects stored in A through E.

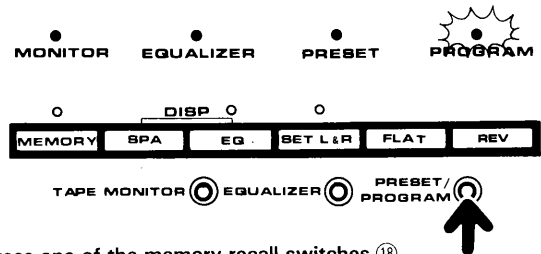

2. Press one of the memory recall switches ⑱.

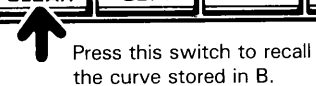
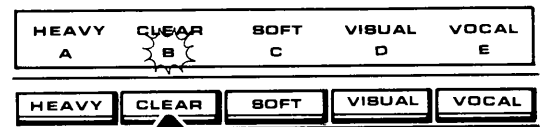

Press this switch to recall the curve stored in B.

USING THE REVERSE SWITCH

This turns the current equalization curve upside down. After recording a tape with equalization, you can return the sound to normal by turning on this switch with the same equalization setting.

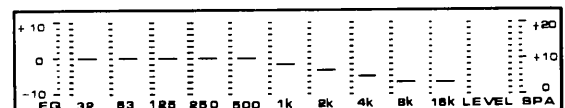
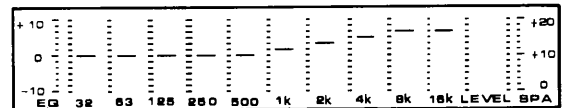

USING THE EQUALIZER CONTROLS

The graphic equalizer gives you precise control over particular bands of frequencies. You can raise or reduce the volume level in each band to obtain many different effects. There are several practical uses for a graphic equalizer, as described below.

1 COMPENSATING FOR SPEAKER OR PHONO CARTRIDGE RESPONSE

Most speakers and phono cartridges have peaks and dips in their frequency response. The equalizer can be used to compensate for these irregularities.

2 COMPENSATING FOR ROOM ACOUSTICS

A room's size, furnishings, and the speaker system position will all affect the acoustic response. Try adjusting the equalizer controls to achieve a balanced sound that is not excessively bright or boomy.

Rooms furnished with carpets, curtains, and stuffed furniture will absorb sound waves. Raise the level at 63Hz and 2kHz to recover lost bass and treble.

Rooms having exposed hard surfaces will reflect sound waves. Try raising the level at 125Hz to achieve more balanced response.

These are only suggestions. Each room is different, and the sound changes with your listening position as well.

3 ACTIVE EQUALIZATION — COLORING THE SOUND

Professional recording engineers use graphic equalizers to bring out particular instruments and to "color" the sound by emphasizing particular tones.

You too can actively equalize the music by adjusting the equalizer controls.

For example, boosting the level at 63Hz will give a bass drum more punch. Boosting the level at 1kHz will bring the vocals forward, adding more presence. Boosting the level at 8kHz will create a brighter cymbal sound.

The harmonics of each instrument are also important, so tonal qualities will change even when you adjust equalizer controls for frequencies outside of the instrument's fundamental range.

NOTE:

To protect speakers from overload damage, do not raise amplifier volume excessively when boosting the treble frequencies.

4 MAKING EQUALIZED RECORDINGS

Special effects

Many interesting, if not musical, effects are also possible. For example, you can create a telephone-like sound by raising the level at 500Hz, 1kHz, and 2kHz, while lowering all the other frequency levels.

Preventing feedback during mixing play

When mixing a microphone with another source, you may notice acoustic feedback or "howling." This can be prevented by lowering the level at the frequency where the feedback occurs. This can be done during recording as well as playback.

Making portable and car stereo tapes

Specially equalized recordings can be made for your car stereo system or for a portable music system. Simply boost those frequency levels that seem to be lacking in your other system, and reduce the level of frequencies that seem excessive.

Noise reduction

You can reduce treble hiss by boosting the high frequencies in a stepped pattern during recording, and then using the reverse switch to lower the same frequencies during playback.

- | | |
|--------------|-------------------|
| ① Cymbals | ⑬ Trombone |
| ② Soprano | ⑭ Piccolo |
| ③ Alto | ⑮ Flute |
| ④ Tenor | ⑯ Alto clarinet |
| ⑤ Baritone | ⑰ Tenor saxophone |
| ⑥ Bass | ⑱ Oboe |
| ⑦ Violin | ⑲ English horn |
| ⑧ Cello | ⑳ Bassoon |
| ⑨ Contrabass | ㉑ Bass drum |
| ⑩ Guitar | ㉒ Pipe organ |
| ⑪ Piano | ㉓ Electric Organ |
| ⑫ Trumpet | |

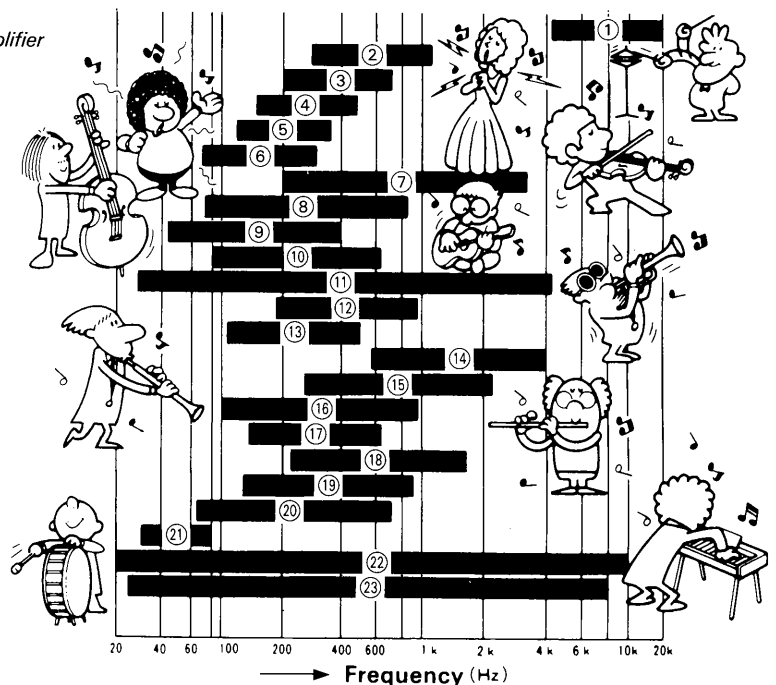

TROUBLESHOOTING

Incorrect operations are often mistaken for trouble and malfunctions. If you think that there is something wrong with this component, check the points below. Sometimes the trouble may lie in another component. Investigate the other components and electrical appliances being used. If the trouble cannot be rectified even after exercising the checks listed below, ask your nearest PIONEER authorized service center or your dealer to carry out repair work.

Symptom	Cause	Remedy
No sound.	<ul style="list-style-type: none"> • Power switch is OFF. • Power cord is not connected. • TAPE MONITOR switch is ON. • Incorrect operation of stereo amplifier. 	<ul style="list-style-type: none"> • Turn power switch on. • Plug in power cord. • Set TAPE MONITOR switch to OFF. • Check the settings of the amplifier switches. (Consult the amplifier operating instructions.) • Connect the cords properly.
No graphic equalizer effects.	<ul style="list-style-type: none"> • Connecting cords are disconnected. • EQUALIZER switch is set to OFF. 	<ul style="list-style-type: none"> • Set to ON.

SWITCH FUNCTION DIAGRAM

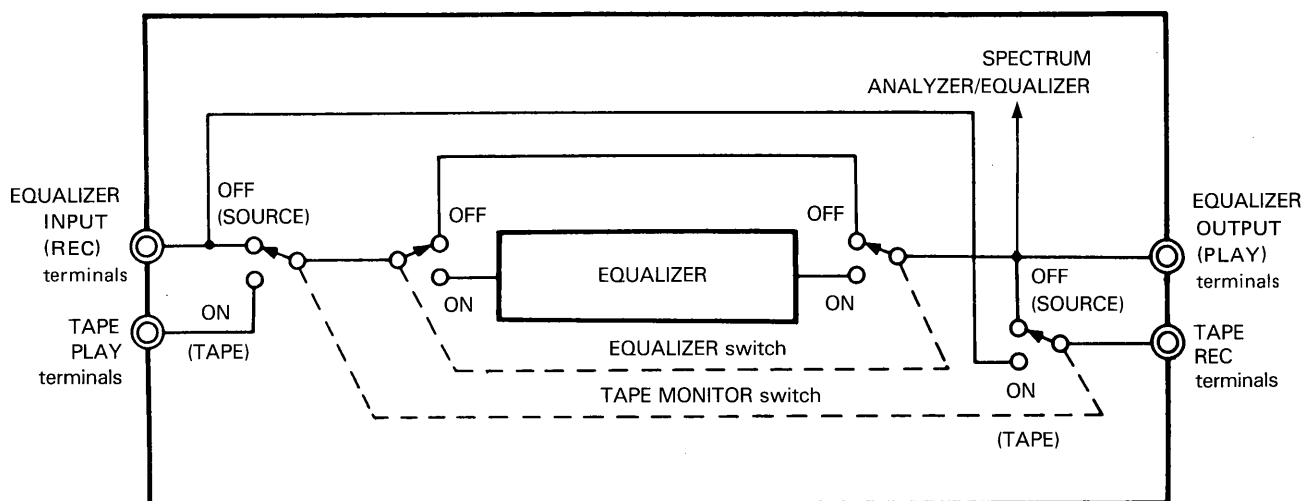

Above diagram shows L channel only.

SPECIFICATIONS

Graphic Equalizer Section

Number of bands 10 + 10
 Equalizer bands
 Center frequencies..... 32 Hz, 63Hz, 125 Hz, 250 Hz, 500 Hz,
 1 kHz, 2 kHz, 4kHz, 8kHz, 16kHz
 Variable range..... ± 10dB
 SN ratio (IHF, A network, short circuit, 1 V) 110 dB
 SN ratio (DIN 500 mV) 90 dB
 Harmonic distortion (20 Hz — 20 kHz, output 1 V)..... 0.02%
 Frequency response 5 Hz — 70 kHz $\pm 0_{-3}$ dB
 Input (Sensitivity/Impedance)..... 150 mV/50 k Ω
 Output (Level/Impedance)..... 150 mV/3.3 k Ω

Spectrum analyzer section

Number of bands 10 + 10
 Center frequencies 32 Hz, 63Hz, 125 Hz, 250 Hz, 500 Hz,
 1 kHz, 2 kHz, 4kHz, 8kHz, 16kHz
 Resolution 2 dB step 13 point

Miscellaneous

Power requirements
 U.S and Canadian models AC 120 V, 60 Hz
 Other destination model AC 110 V/120 — 127 V/
 220 V/240 V (switchable), 50/60 Hz
 Power consumption 18 W
 External dimensions 420 (W) x 311.5 (D) x 85.5 (H) mm
 16-9/16 (W) x 12-1/4 (D) x 3-3/8 (H) in.
 Weight 4.0 kg (8 lb 13 oz)

ACCESSORIES

Stereo connection cords 2
 Operating instructions 1
 Remote control unit 1
 Battery 2

Specifications and design subject to possible change without notice, due to improvements.

PIONEER ELECTRONIC CORPORATION 4-1, Meguro 1-Chome, Meguro-ku, Tokyo 153, Japan

PIONEER ELECTRONICS [USA] INC. 2265 East 220th Street Long Beach, California 90810 U.S.A.
 P.O. BOX 1720 Long Beach, California 90801-1720 U.S.A.

PIONEER ELECTRONICS OF CANADA, INC. 505 Cochrane Drive, Markham, Ontario L3R 8E3 Canada

PIONEER ELECTRONIC [EUROPE] N.V. Keetberglaan 1, 2740 Beveren, Belgium TEL: 03/775-28-08

PIONEER ELECTRONICS AUSTRALIA PTY. LTD. 178-184 Boundary Road, Braeside, Victoria 3195, Australia TEL: [03] 580-9911