

STEREO RECEIVER

SX-535

OPERATING INSTRUCTIONS

FV
GN
KCU



 PIONEER®

FEATURES

Advanced Tuner Section

- FM tuner section using high stability circuitry.
- FM front end with FET and rectilinear frequency three stage variable capacitor.
- IF amplifier circuitry with high reliable integrated circuits developed by Pioneer.
- Incorporation of two twin-element phase-linear ceramic filters and high stability circuitry components makes for excellent image rejection, superior capture ratio, improved SN ratio plus selectivity — in short, tip-top performance all round.
- Phase Locked Loop circuitry is used in the multiplex circuit to prevent deterioration due to temperature changes and the passage of time.
- Pioneer's low distortion and excellent separation characteristics provide for stable operation which ensures enhanced FM stereo listening pleasure for you.

Low Distortion, Wide Range Power Amplifier

Thanks to the use of extra-reliable NPN and PNP silicon power transistors and a differential one-stage, completely and superior frequency characteristics are assured.

Moreover, the output range and the distortion characteristics are greatly improved.

The differential amplifier circuit and the temperature compensation circuit further ensure that the stability and superior performance of the Receiver are not subject to external conditions, and this adds up to extra stereo listening pleasure for the customer.

High Fidelity Preamplifier

The utilization of the finest components available in the equalizer circuit keeps deviation from the RIAA standards down to a minimum, thereby making an important contribution to the faithfulness of record reproduction.

A Receiver which can Handle any Program Source

Amongst the input jacks on the back panel are turntable and auxiliary connectors, two separate tape deck terminals (for cassette decks or open-reel decks) plus microphone jack on the front panel, so that any source whatever can be utilized to provide flexible listening pleasure.

Personal Music Library can be Compiled

By connecting two tape decks, the desired portions only can be edited from previously recorded tapes. Duplication of programs from one tape machine to the other tape can also be performed.

Two Sets of Speaker Systems may be Connected

This Receiver is furnished with two sets of speaker terminals on the back panel and the corresponding positions on the speaker selector switch. Thus you can play whatever music you are listening to through two pairs of speaker systems at once, so you can have the same program playing in two separate rooms simultaneously.

Advanced Ultramodern Design

The entire design of this Receiver has been carefully thought out with efficient functioning in mind.

The entirely new-look Receiver will fit in with the decor of your listening room perfectly, thanks to its tasteful wooden cabinetry and top quality appearance.

CONTENTS

Features	2
Line Voltage and Fuse and Rear Panel	3
Installation	3
Stereo System Setup	4
Speaker System Connection	4
Connection Diagram	5
Antenna and Ground Connections	6
Equipment Component Connections	7
Front Panel Facilities	8
How to Operate the Receiver	10
Employing Tape Decks	11
About 4-channel Stereo System	12
Conditions Frequently Mistaken for Malfunction	13
Specifications	14
Mounting Template	15

LINE VOLTAGE AND FUSE AND REAR PANEL

Each design of LINE VOLTAGE and FUSE of this model differs according to each destination to be delivered.

How to operate the SX-535 is quite the same for each version. However, each rear panel differs according to LINE VOLTAGE and FUSE designed for each version.

Fig. A shows the LINE VOLTAGE of a 120V only model.

Fig. B shows the LINE VOLTAGE of a 220V only model.

Fig. C shows a 5 line voltage (110V, 120V, 130V, 220V and 240V) model whose LINE VOLTAGE and FUSE can be changed and set as follows:

CHANGING LINE VOLTAGE SETTING AND FUSE (Fig. D)

To remove the fuse, turn the fuse cap located on the line voltage selector in the direction indicated by the arrow. Then remove the fuse plug from the unit. Put the fuse plug back so that the proper line voltage marking can be seen through the cut in the edge of the plug. Whenever the position of the selector is changed, check the rating of the fuse. A 1.5A fuse is to be used for either 220V or 240V operation and a 3A fuse rating for 110V, 120V or 130V operation. If the rating of the fuse is correct, replace cap.

FUSE REPLACEMENT

When the fuse blows, remove the fuse cap and replace the fuse with a new one.

INSTALLATION

For safety and reliability in addition to protection of the outward appearance of each component, please avoid installing them in any of the following places:

- In direct sunlight or near heating units.
- In a poorly ventilated, dusty, or damp place.
- In an unstable place where is significant vibration or inclination.

In vicinity of AM radio or TV set.

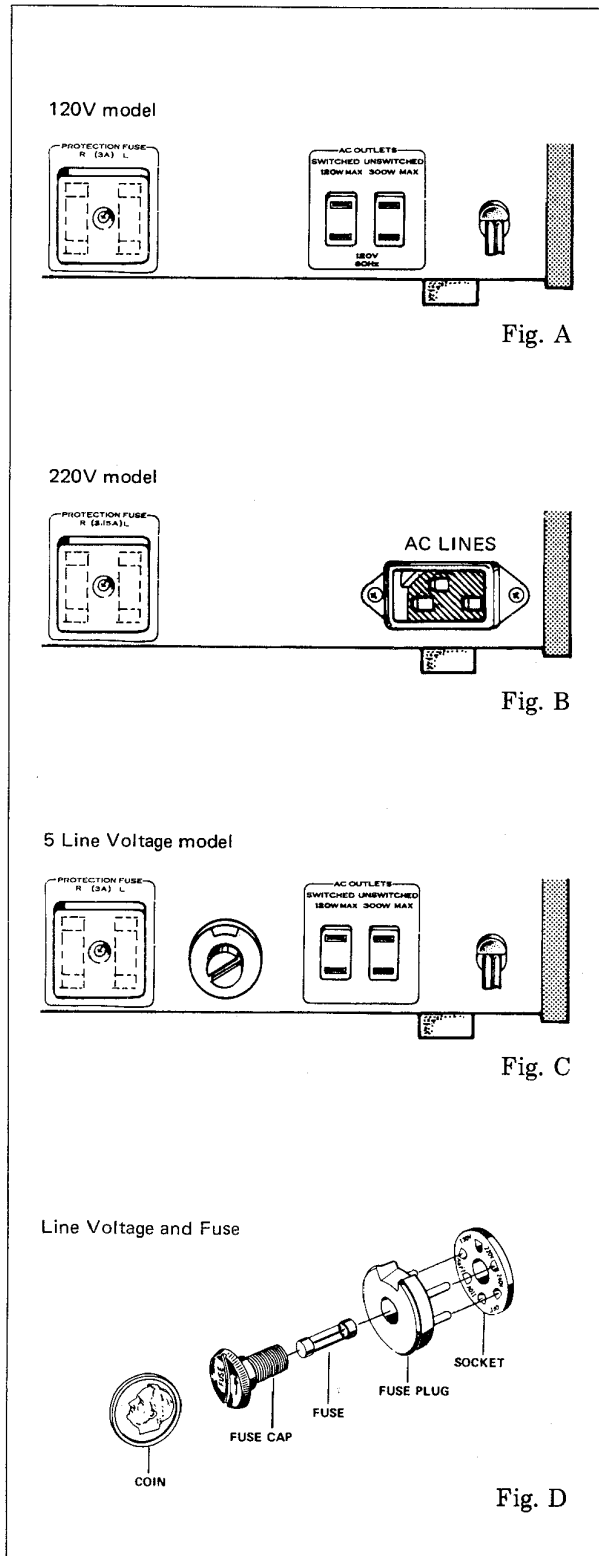

STEREO SYSTEM SETUP

The SX-535 is an integrated AM/FM stereo Receiver ideally suited to form the heart of a stereophonic reproduction system of the highest quality. Use it in conjunction with good quality speaker systems and other components, such as turntable, tape deck (open-reel or cassette), microphone (for public address applications), etc. as shown in Fig. 1.

A WORD ABOUT ROOM ACOUSTICS

The sound heard from an audio system is greatly influenced by conditions of the listening room. The size and shape of the room, materials composing the walls, ceiling and floor, the amount and distribution of furniture, carpets, draperies, etc. all affect the resulting sound. In general, it is advisable to place speakers with their backs against a wall, as this will improve bass response.

Bare rooms with low ceilings, hard floors and hard, reflective walls (especially a hard wall facing the speakers) can produce an excessively "live" brilliant sound with lack of clear instrument localization and definition. It often helps in such cases to place a carpet and heavy, soft curtains in the room. Conversely, a "dead" sound can be caused in rooms containing heavy carpeting and a large amount of upholstered furniture. This can often be improved by re-arranging the furniture.

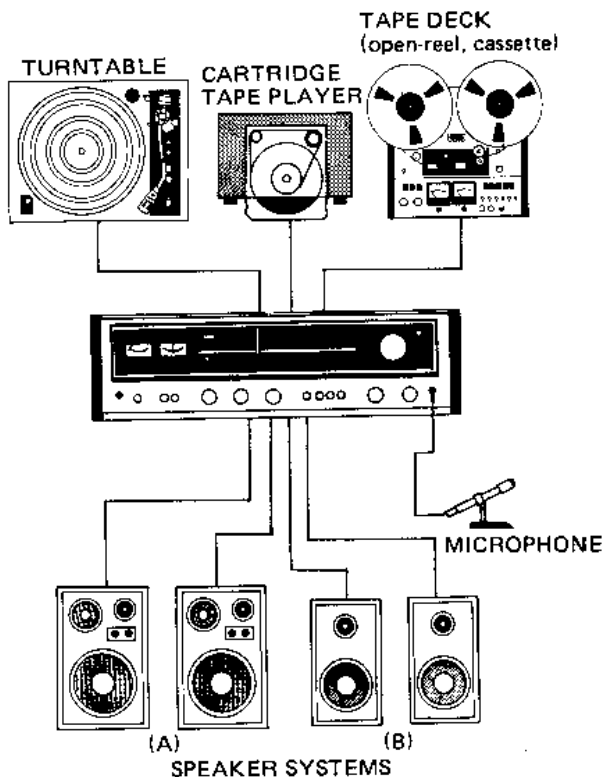

Fig. 1 - Example of components combined with the SX-535.

SPEAKER SYSTEM CONNECTION

Two sets of speaker terminals (A & B) are provided on the Receiver, which allow connection of two sets of speakers.

If only one set of speakers is to be employed, connect them to the A terminals (Fig. 2). Speaker wire is often supplied with the speakers, or available from an audio dealer.

- Connect the right channel speaker (right-hand speaker as viewed from the front) to the speaker terminals marked "R" on the Receiver.
- Connect the left channel speaker (left-hand speaker as viewed from the front) to the speaker terminals marked "L" on the Receiver.

Use common two-conductor lead wire, preferably color coded for easy identification. Be sure to connect the plus (+) terminal (red terminal) of the Receiver with the (+) terminal of the speaker, and the minus (-) terminal (black terminal) of the Receiver with the (-) terminal of the speaker.

A second pair of speakers can be connected to the B speaker terminals in the same way.

NOTE:

When two pairs (A and B) of speakers are to be used at the same time, the impedance of each speaker must be 8 ohms or greater.

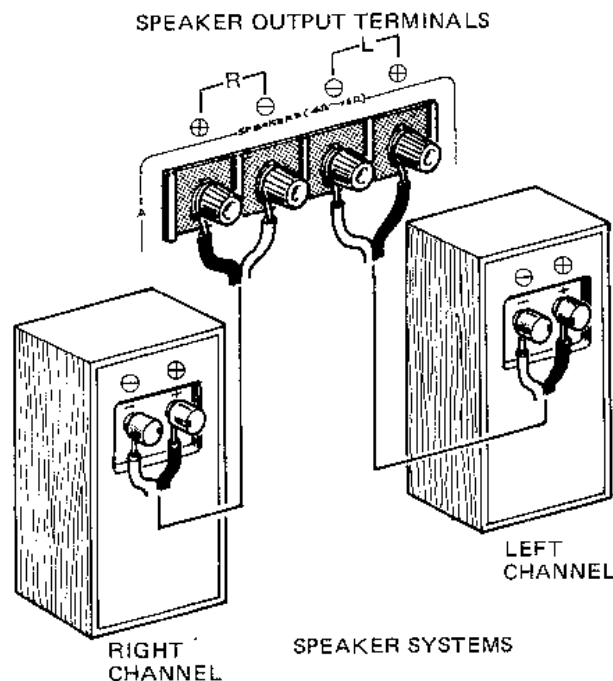
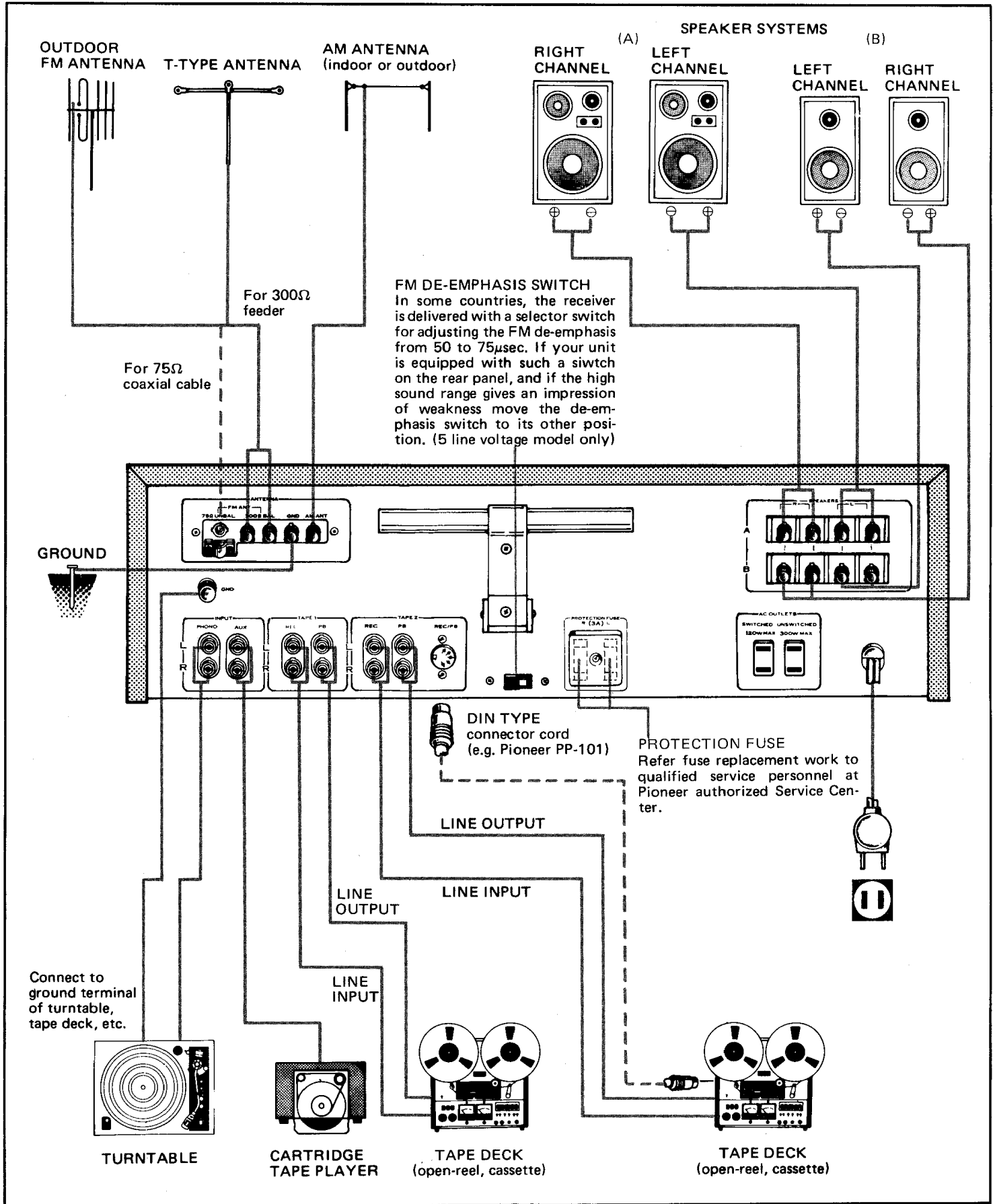

Fig. 2 - Connecting speaker output terminals of the SX-535 to speaker systems.

CONNECTION DIAGRAM



ANTENNA AND GROUND CONNECTIONS

FM ANTENNA CONNECTIONS

An outdoor FM antenna should be employed for best results. The simple T-type antenna supplied with the Receiver may be used satisfactorily in high signal strength areas (near FM broadcast station or in an all-wooden house).

- Connect antenna feeder wire to the FM ANTENNA terminals of the Receiver (Figs. 3, 5).
- While listening to an FM station, locate and position the antenna for best reception, as described in "FM Reception" on page 10.

NOTE:

Many types of FM antennas are available. Consult an audio dealer for assistance in selecting the best.

Connections with Coaxial Cable

In certain locations, such as urban areas with high traffic density, industrial zones, or near high voltage power lines, objectionable interference may be present even with the use of a special-purpose outdoor FM antenna. A local audio dealer should be consulted regarding the advisability of connecting the antenna and Receiver with 75Ω coaxial cable. Coaxial cable connections are as shown in Fig. 4.

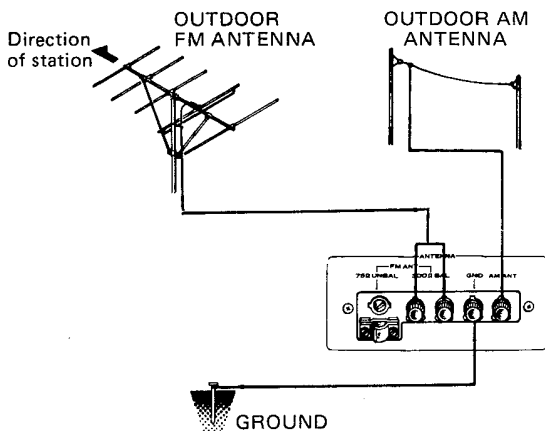

Fig. 3

AM ANTENNA CONNECTION

Under normal conditions, optimum reception can be obtained by simply adjusting the ferrite bar antenna on the rear panel of the Receiver (Fig. 6) and operating the Receiver as described in "AM Reception" on page 10.

If reception is still noisy or weak with the bar antenna, an indoor lead antenna or outdoor antenna can be connected. Connect the antenna lead wire to the AM ANTENNA terminal of the Receiver (Figs. 3, 5).

- Use vinyl-covered wire as shown in Fig. 5 for the indoor lead antenna.
- An outdoor antenna can be set up as shown in Fig. 3 by suspending vinyl-covered wire between two supports.

GROUND CONNECTION

For considerations of safety and elimination of interference, it is advisable to install a ground wire as shown in Fig. 3 wherever possible.

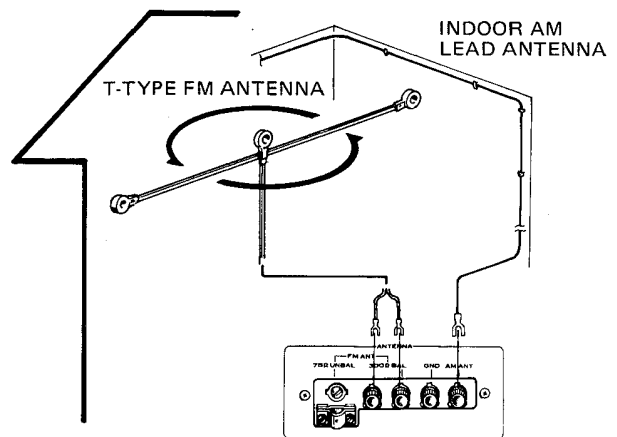

Fig. 5

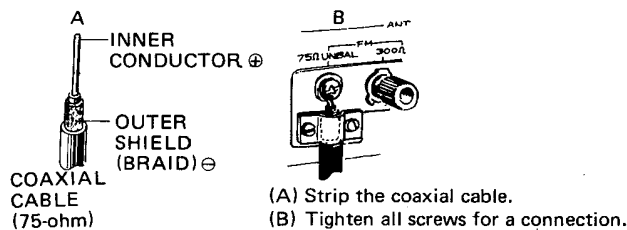

Fig. 4 — Connect coaxial cable to 75Ω UNBAL.

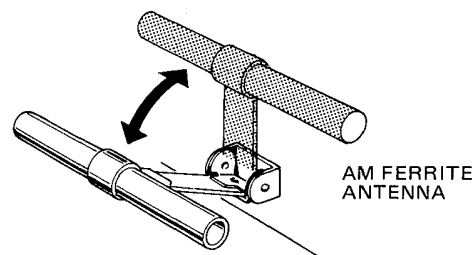

Fig. 6 — Adjust AM broadcast reception with this AM ferrite bar antenna.

EQUIPMENT COMPONENT CONNECTIONS

TURNTABLE CONNECTION

A stereo turntable with a moving magnetic (MM) cartridge can be connected to the PHONO input jacks (Fig. 7).

The upper jack is for the left channel output cable from the turntable, and the lower jack for the right channel cable. The ground wire or plug from the turntable should be connected to the GND terminal of the Receiver.

NOTE:

A moving coil (MC) phono cartridge of low output voltage can be used only in combination with a separate booster transformer or head amplifier.

AUX INPUT JACKS

These jacks are provided for auxiliary inputs. They can be employed for connecting the stereo output leads from a cartridge tape player, from TV sound tuner set, etc.

The upper jack is for the left (L) channel and lower jack for the right (R) channel.

TAPE DECK CONNECTIONS

The Receiver is provided with two sets of recording output (TAPE 1 & 2 REC) and two sets of playback input (TAPE 1 & 2 PB) jacks, in addition to a DIN type recording/playback connector (TAPE 2 REC/PB). These permit both normal tape recording and playback, plus by employing two tape decks, tapes can be duplicated, from one machine to the other. Use the connecting cords supplied with the tape decks to make the connections.

Connections for Recording

- Connect the Receiver TAPE 1 REC output jacks to the tape deck recording input jacks (LINE INPUT), as shown in Fig. 8. The upper jack is for the left (L) channel and the lower for the right (R) channel.
- When using two tape decks, the second machine should be connected to the Receiver TAPE 2 REC output jacks. However, if one machine is connected to the DIN record/playback connector, connect the other tape deck to the TAPE 1 REC output jacks.

Connections for Playback

- Connect the Receiver TAPE 1 PB input jacks to the playback output jacks (LINE OUTPUT or TAPE MONITOR) of the tape deck. The upper jack is for the left (L) channel, and the lower jack for the right (R) channel.
- When using two tape decks, the second should be connected to the Receiver TAPE 2 PB input jacks. However, if one machine is connected to the DIN record/playback connector, connect the other tape deck to the TAPE 1 PB input jacks.

Connection of TAPE 2 REC/PB

If the tape deck is provided with a DIN type record/playback connector, use an optional recording/playback cord (e.g. Pioneer PP-101) and connect with the TAPE 2 REC/PB DIN connector of the Receiver. This eliminates separate connections to either the TAPE 2 REC output or TAPE 2 PB input jack (Fig. 9).

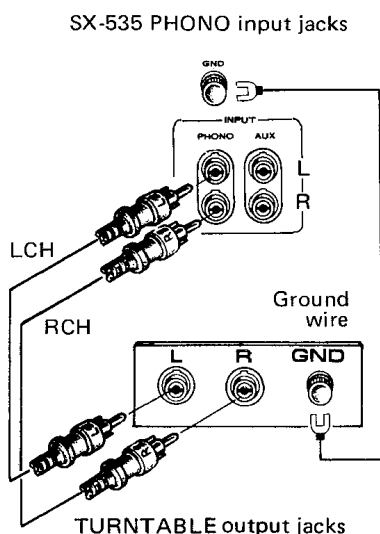

Fig. 7 — Connecting the SX-535 to turntable.

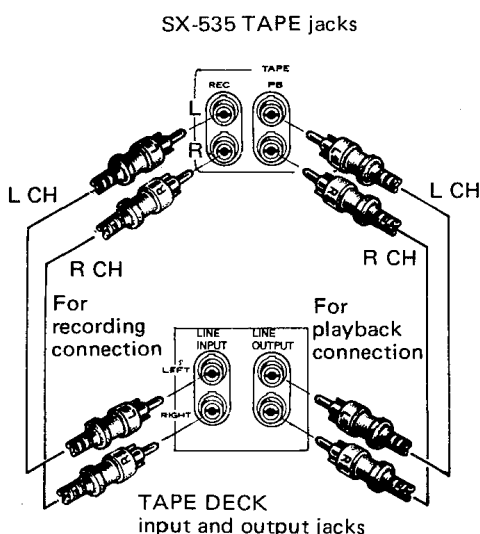

Fig. 8 — Connecting the SX-535 to tape deck.

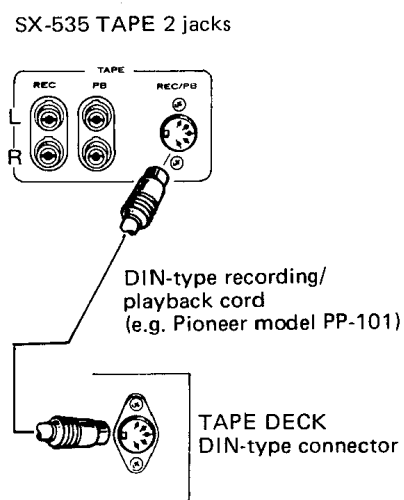

Fig. 9 — Connecting the SX-535 with REC/PB (DIN-type) connector.

FRONT PANEL FACILITIES

SIGNAL METER

Tune in both AM and FM stations for maximum deflection of the meter indicator to the right.

FM TUNING METER

When tuning in an FM station, first employ the SIGNAL meter, then perform fine tuning adjustment in order to center the needle of this meter.

PHONES JACK

For plugging in stereo headphones. A wide variety of high quality headphones are available from Pioneer.

POWER BUTTON

AC power is turned on by pushing this switch to ON.

SPEAKER BUTTONS

Buttons for selecting A or B speaker system connected to A or B output terminals.

- A: Speaker system A operates.
- B: Speaker system B operates.

NOTES:

1. When employing headphones, speakers can be turned off by setting the *SPEAKERS* buttons to the *OFF* (unpushed) position.
2. Two pairs (A, B) of speaker systems can be used at the same time with A and B switches pushed.

BASS & TREBLE CONTROLS

Adjust bass and treble. Flat response is obtained at center of rotation. Turning the controls clockwise or counterclockwise from center will boost or diminish the tone as desired.

BALANCE CONTROL

Adjusts balance between left and right speakers. When turned clockwise, left channel volume decreases while right channel volume increases. Turning the control counterclockwise has the opposite effect.

MODE BUTTON

Selects stereo or mono sound.

- STEREO: Leave it unpushed.
- MONO: Push it for monophonic sound into which the left and right channel signals blend.

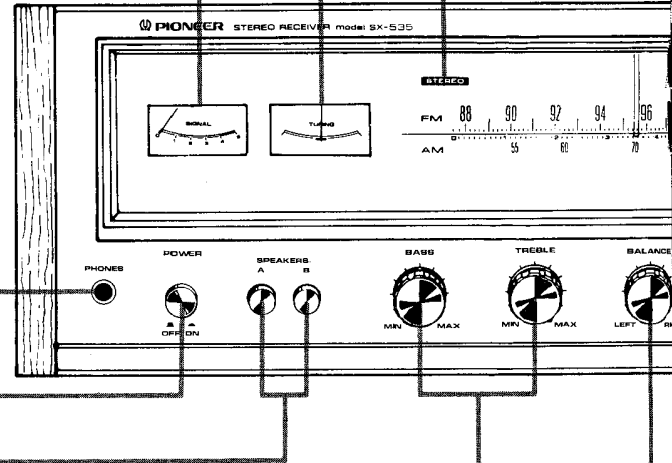

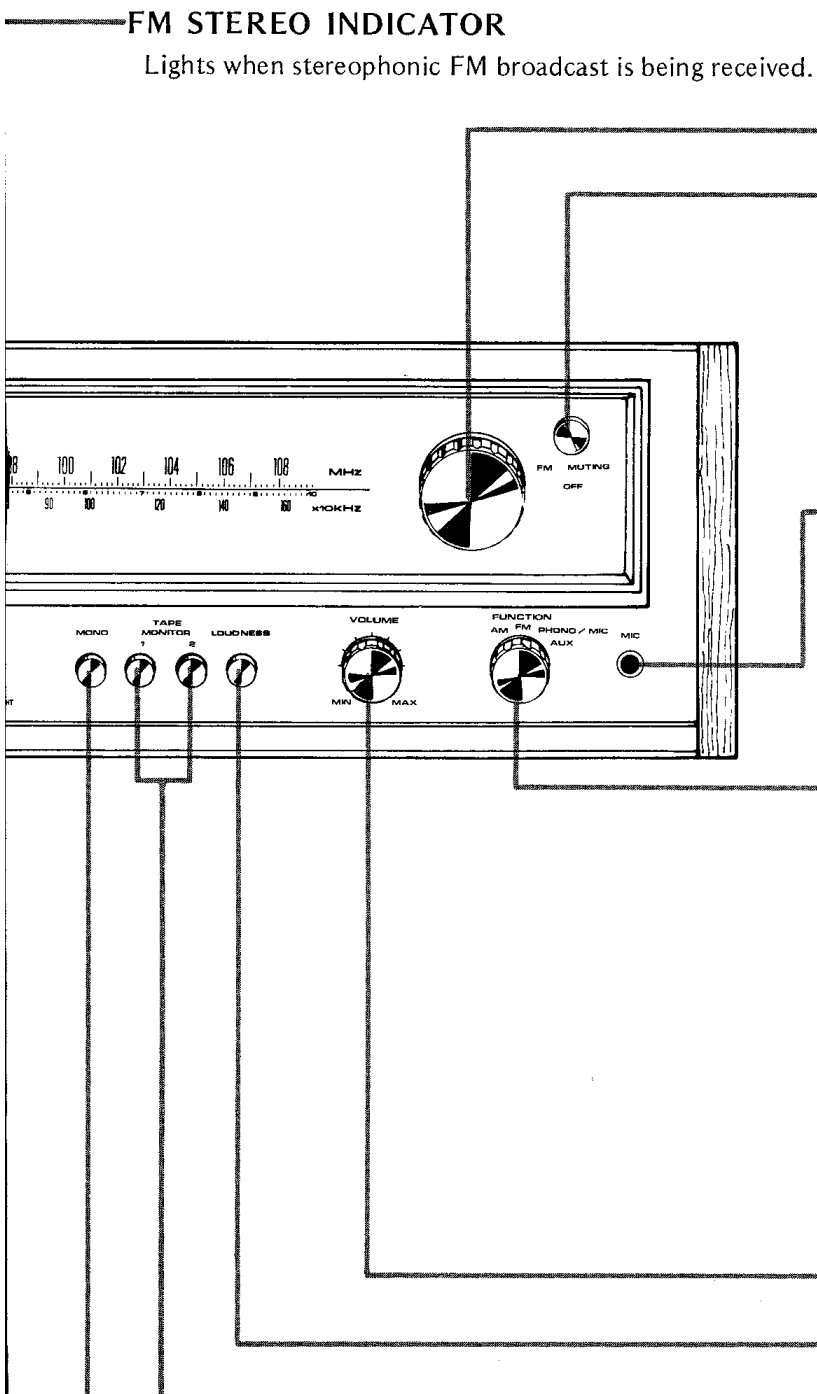

FM STEREO INDICATOR

Lights when stereophonic FM broadcast is being received.

TUNING CONTROL

Turn this knob to tune in desired broadcast station.

FM MUTING BUTTON

Leave this button unpushed (ON) when listening to FM broadcasts. This will suppress inter-station noise and weak interfering stations when tuning in a desired station. If the desired station is weak, however, push this button to the OFF position.

MIC JACK

Accepts the plug of the microphone. When a microphone is connected to the MIC jack, the turntable connected to PHONO terminals cannot be used. Use a high-impedance microphone with a standard plug.

FUNCTION SWITCH

Selects desired program source.

AM: AM reception.

FM: FM reception with automatic switching for stereo or mono programs. The STEREO indicator lights when the broadcast is in stereo.

PHONO/MIC: When playing records or using a microphone.

AUX: To play component connected to the AUX input jacks.

VOLUME CONTROL

Adjusts sound volume of both speakers and headphones. Clockwise rotation increases volume.

TAPE MONITOR (1 & 2) BUTTONS

These buttons permit the recorded sound to be monitored when recording with a tape deck. They also allow listening to tapes (playback).

1 Push this button when tape deck connected to TAPE 1 (REC & PB) jacks are being used for playback, or for monitoring a recording in progress.

2 Push this button when tape deck connected to TAPE 2 (REC & PB or REC/PB.DIN connector) jacks are being used for playback, or for monitoring a recording in progress.

LOUDNESS BUTTON

Compensates for human ear response to low sound volumes. Push this button to ON to enhance low and high frequencies when listening at low volume levels.

HOW TO OPERATE THE RECEIVER

BEFORE SWITCHING ON THE POWER

Before switching on the power, set the controls and switches of the Receiver as follows:

- VOLUME control to MIN.
- BALANCE control to center of rotation.
- TAPE MONITOR (1 & 2) buttons to OFF (unpushed).
- BASS & TREBLE controls to center of rotation.
- MODE button to STEREO (unpushed position).
- FM MUTING button to ON (unpushed position).
- SPEAKERS A button to ON (If the speaker system is connected to the B output terminals, use SPEAKERS B button).

It is important to set these controls as indicated to avoid undue overload on the Receiver or speakers when the power is switched ON.

FM RECEPTION

1. Set the FUNCTION switch to FM.
2. Set the FM MUTING button to ON (unpushed position).

In areas where the signal strength is weak, the desired signal may become suppressed. In this case, push the button to the OFF position.

3. Select desired station by turning the TUNING knob. Best reception is obtained when the SIGNAL meter deflects to the extreme right and the TUNING meter is exactly in the center (Fig. 10). The STEREO indicator lamp will light if the broadcast is in stereo. It will not light for monophonic broadcasts.
4. Adjust sound loudness with the VOLUME control and set the BASS and TREBLE controls according to preferred tone quality.

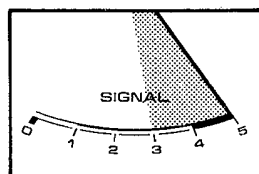

SIGNAL METER
(Both for AM and FM Reception)

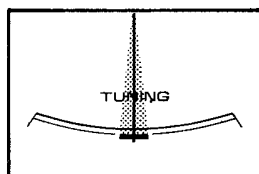

TUNING METER
(Only for FM Reception)

Fig. 10 — Meter needles deflection.

AM RECEPTION

1. Set the FUNCTION switch to AM.
2. Select desired station by turning the TUNING knob. Best reception is obtained when the SIGNAL meter deflects to the extreme right (Fig. 10).
3. Adjust VOLUME, BASS and TREBLE controls for preferred loudness and tone quality.

NOTE:

If poor sensitivity or heavy interference are incurred when listening to FM or AM broadcasts, refer to the section "ANTENNA AND GROUND CONNECTIONS" on page 6 and perform necessary changes.

RECORD PLAYING

1. Set the FUNCTION switch to PHONO/MIC.
2. Play record on turntable.
3. Adjust VOLUME, BASS and TREBLE controls for preferred loudness and tone quality.

EMPLOYING MICROPHONE

1. Connect microphone to the MIC jack.
 2. Set the FUNCTION switch to PHONO/MIC.
 3. Adjust sound level by gradually turning the VOLUME control clockwise. Best setting for the BASS and TREBLE controls is generally center of rotation.
- No microphone mixing can be performed with the SX-535.

NOTES:

1. Employ high impedance (above 20k Ω) microphones with standard 6mm diameter phone plugs. Pioneer manufactures a broad selection of high performance microphones.
2. Feedback noise can be incurred when using a microphone under certain conditions. Use care not to excessively increase the volume when the microphone is near a speaker or in a highly resonant room. The most effective setting for the BASS and TREBLE controls is at their center positions.
3. While using the microphone, only monophonic sound is heard from the left and right speaker systems.

EMPLOYING AUX JACKS

Operate as follows when playing equipment connected to the AUX jacks.

1. Set the FUNCTION switch to AUX.
2. Operate connected component.
3. Adjust VOLUME, BASS and TREBLE controls for preferred loudness and tone quality.

EMPLOYING TAPE DECKS

PLAYBACK

1. According to the TAPE PB (1 & 2) jacks to which the tape deck is connected, set either TAPE MONITOR 1 or TAPE MONITOR 2 button to ON (Fig. 11).
2. Operate tape deck for playback.
3. Adjust VOLUME, BASS and TREBLE controls for preferred loudness and tone quality.

NOTES:

1. Setting the TAPE MONITOR button to ON permits tape playback regardless of the FUNCTION switch setting.
2. Be sure to turn the TAPE MONITOR (1 or 2) switch not in use to OFF.

RECORDING

The source selected by the FUNCTION switch is present at a fixed output level at the TAPE REC (1 & 2) jacks. Connecting a tape deck to these jacks allows the source to be recorded. Perform as follows:

1. Set the FUNCTION switch for the source to be recorded.
2. Play the selected program source.
3. Employ the controls of the tape deck to adjust the recording level and begin recording. The Receiver VOLUME, BASS and TREBLE controls have no effect on the recorded sound.

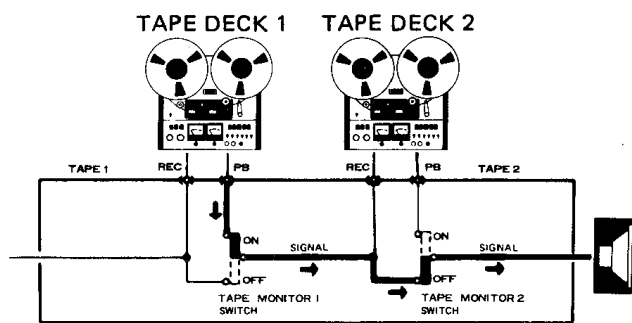

Fig. 11 – Tape playback: Tape playback signal flows from the PB jacks of TAPE 1 and TAPE 2 in the arrow-indicated direction, with the SX-535 TAPE MONITOR switch set to ON.

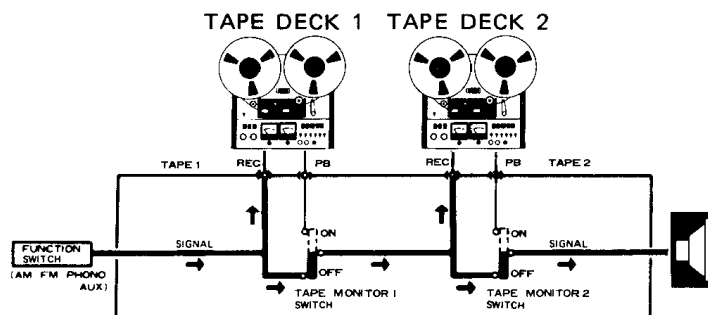

Fig. 12 – Tape recording: Signal selected by the SX-535 FUNCTION switch flows in the arrow-indicated direction and is present at the REC jacks of TAPE 1 and TAPE 2.

Tape Monitoring

While a recording is being made on a 3-head tape deck, by setting the TAPE MONITOR button to ON, the sound being recorded can be monitored through the speakers. Both recording and playback connections must be performed in this case.

As mentioned in Recording, do not switch the TAPE MONITOR 1 switch to ON when recording on two tape decks at the same time. Leave the switch OFF.

Tape Duplication and Editing

By employing two tape decks, the desired music portions only from a previously recorded FM broadcast etc. can be re-recorded onto another tape. A personal tape library can be compiled in this way.

1. Connect tape decks to TAPE 1 & 2 jacks as shown in Fig. 13.
2. Set TAPE MONITOR 1 button at ON. Put the recorded tape on tape deck 1. Set this deck in playback operation.
3. Put a blank tape on tape deck 2, set this deck in recording mode. Stop tape travel of deck 2 during unwanted passages.
4. The recording taking place on deck 2 can be monitored by setting the TAPE MONITOR 2 button at ON.

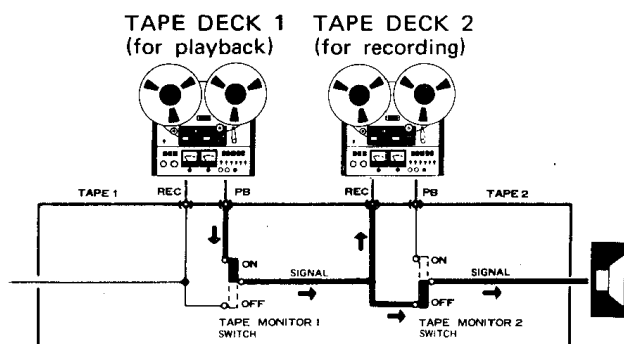

Fig. 13 – Tape Duplicate: With the TAPE MONITOR 1 switch to ON, the signal played back by tape deck 1 can be recorded on tape deck 2, while the signal is flowing in the arrow-indicated direction.

ABOUT 4-CHANNEL STEREO SYSTEM

A 4-channel stereo system requires four speakers, front left & right and rear left & right, as illustrated below. This gives a whole new dimension of realism not attainable with conventional 2-channel stereo. It offers the sense of the acoustics of the hall — and the atmosphere and applause — where the recording was made. The unique sense of “presence” of being “actually there” which 4-

channel stereo alone can give, has to be experienced before it can be appreciated.

Presently available 4-channel systems consist of matrix (RM & SQ) and discrete (4-channel tape & CD-4 records). As shown below, a 4-channel system can be composed with the Receiver by connecting the appropriate adaptors for each system.

PLAYBACK OF MATRIX-SYSTEM PROGRAM SOURCES

Illustration below shows how RM and SQ decoders play back matrix-system 4-channel program sources.

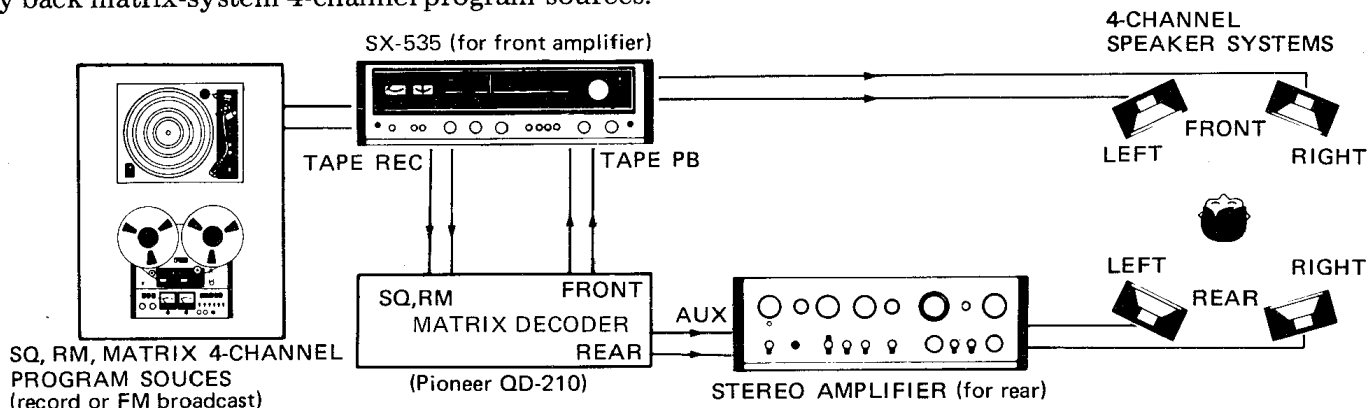

PLAYBACK OF DISCRETE-SYSTEM PROGRAM SOURCES

Playback of CD-4 Records

Illustration below shows how CD-4 demodulator plays back CD-4 records.

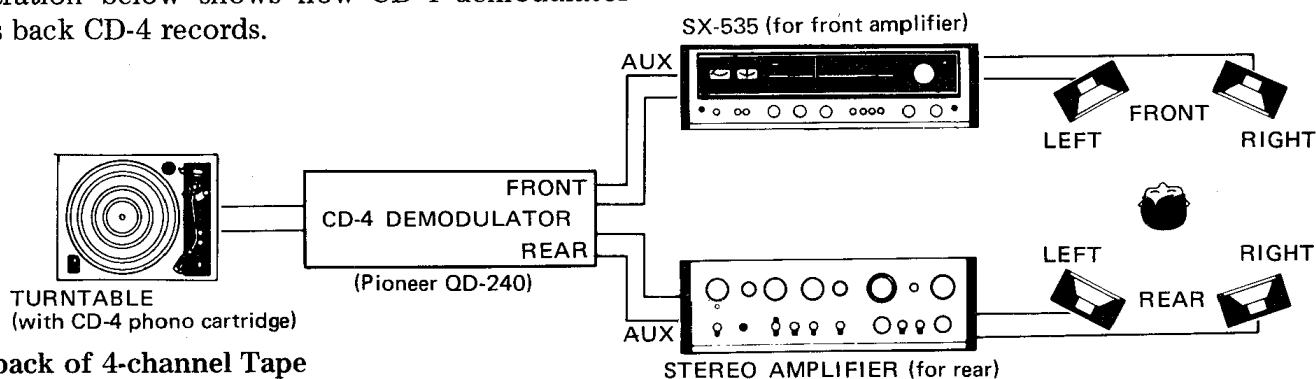

Playback of 4-channel Tape

Illustration below shows how a 4-channel tape deck plays back a discrete 4-channel tape.

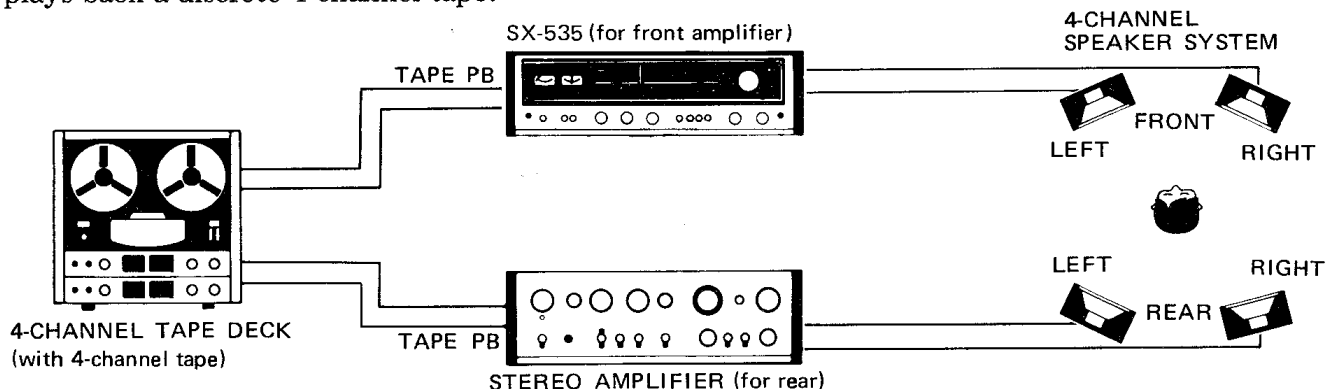

CONDITIONS FREQUENTLY MISTAKEN FOR MALFUNCTION

	SYMPTOM	SUSPECTED SOURCE OF NOISE	DIAGNOSIS AND REMEDY
WHEN LISTENING TO BROADCASTS	Continuous or intermittent noise like jiiiii or zzzzzz.	<ul style="list-style-type: none"> • Static (lightning) • Fluorescent lamp, motor, or thermostat may be in use in house or in the vicinity of the house. 	In many cases, it is very difficult to remove the source of noise. In order to make the radio input larger than the noise level, set up a good outdoor antenna and make a complete grounding.
	When a station is tuned in, hum is mixed in the program.	<ul style="list-style-type: none"> • Poor fluorescent lamp, motor, or electric heater may be in use in house or near the house. 	Reversing the line plug may occasionally alleviate this noise problem. Usually it is very difficult to eliminate the noise.
	Hissing sound noise in AM (medium wave) reception.	<ul style="list-style-type: none"> • The frequency of an adjacent station is interfering with that of the station being tuned in (10kHz beat interference). • TV set is on in the same house with the receiver. 	Impossible to remove such interference. If the case of such noise is in the TV set, increase the distance between the TV set and receiver.
	Static noise (in particular, when automobiles run close to the house).	<ul style="list-style-type: none"> • White noise generated from automobile engines. • High frequency sewing machine or welding machine being used near your house. 	In an area surrounded by hills or high buildings, the FM input signals are very weak. Thus the noise limiter in the circuit loses its function. Set up an FM outdoor antenna having many director elements.
	Reception of FM stereo program contains more noise than FM mono program.	<ul style="list-style-type: none"> • Note that the service area covered by an FM stereo broadcast is about 50% of that of a regular mono broadcast. 	Increasing FM input signal may alleviate this problem. Use an exclusive FM outdoor antenna instead of the indoor T-type antenna.
WHEN PLAYING RECORDS	Hum or buzz. When switched to radio reception, the noise disappears.	<ul style="list-style-type: none"> • Poor connection of shielded wire. (a) • Jack connection is loose. (b) • Line cord of fluorescent lamp is near the shielded wire. (c) • Poor grounding. (d) • Ham transmitting station or TV transmitting station is near your house. (e) 	Correct the conditions stated in (a), (b), (c) or (d). In case of (e), report it to an official activity.
	Output tone quality is poor and mixed with noise. Treble is not clear.	<ul style="list-style-type: none"> • Stylus wears out. (a) • Record wears out. (b) • Dust adheres to stylus. (c) • Stylus is improperly mounted. (d) • Stylus pressure is not proper. (e) • The TREBLE level is too high. 	<p>Check (a) through (e) and correct the condition.</p> <p>Lower the TREBLE level.</p>

WATCH FOR THE FOLLOWING CONDITIONS; THESE ARE ALSO APT TO BE MISTAKEN FOR MALFUNCTIONS.

	SYMPTOM	SUSPECTED SOURCE OF NOISE	DIAGNOSIS AND REMEDY
	Power is not turned on although the power switch is set to ON.	<ul style="list-style-type: none"> • Fuse blows. (a) • Line plug is loose. (b) 	Check (a) and (b) and correct the condition.
	Power ON but speakers produce no sound.	<ul style="list-style-type: none"> • Blown-out PROTECTION fuse. 	Refer fuse replacement work to qualified service personnel at Pioneer authorized Service Center.
	In playing a record, increasing the volume causes howling.	<ul style="list-style-type: none"> • Distance between the turntable and the speakers is too short. • The place on which the turntable or speakers are set is unstable. 	<p>Change the distance or rearrange the installation increase of the unit and speakers. (Installing the turntable on a firm, solid stand may alleviate this problem.)</p> <p>Do not enhance the BASS sound level excessively.</p>

SPECIFICATIONS

Semiconductors

FET	1
ICs	3
Transistors	29
Diodes	15

Amplifier Section

Continuous Power Output

40Hz~20kHz (Both channels driven)	20W + 20W (8Ω, Rated power)
	22W + 22W (4Ω)
1kHz (Both channels driven)	22W + 22W (8Ω)
	25W + 25W (4Ω)

Harmonic Distortion

(40Hz~20kHz Continuous Power Output)	Less than 0.8%
(1W + 1W, Power Output)	Less than 0.08%

Intermodulation Distortion

(Continuous Power Output)	Less than 0.8%
(1W + 1W, Power Output)	Less than 0.08%

Power Bandwidth

(IHF, Both channels driven)	10Hz~70kHz (T.H.D. 0.8%)
-----------------------------	-----------------------------

Output Speaker	A, B, A + B, (4Ω~16Ω)
Headphone	4Ω~16Ω

Damping Factor (1kHz, 8Ω)	More than 30
---------------------------	--------------

Residual Hum & Noise

(8Ω, Pre & Power amplifier)	Less than 0.5mV
-----------------------------	-----------------

Input Sensitivity/Impedance

PHONO	2.5mV/50kΩ
PHONO Overload Level (rms/p-p)	110mV/310mV
MIC	7mV/85kΩ
AUX	150mV/75kΩ
TAPE PB 1, 2	150mV/75kΩ
TAPE PB 2 (DIN connector)	150mV/75kΩ

Output Level/Impedance

TAPE REC 1, 2	150mV
TAPE REC 2 (DIN connector)	30mV/80kΩ

Frequency Response

PHONO (RIAA equalization)	30Hz~15kHz ±0.5dB
AUX, TAPE PB	20Hz~30kHz ±1dB

Tone Control

BASS	+9dB, -8dB (100Hz)
TREBLE	±6dB (10kHz)

Loudness Contour (Volume control set at

-40dB position)	+10dB (100Hz), +5dB (10kHz)
-----------------	-----------------------------

Hum & Noise (IHF, short-circuited, A Network)

PHONO	More than 70dB
MIC	More than 65dB
AUX, TAPE PB	More than 90dB

FM Section

Usable Sensitivity (IHF)	1.9μV
Capture Ratio (IHF)	1.0dB
Selectivity (IHF)	60dB
Signal-to-Noise Ratio	70dB
Image Rejection (98MHz)	60dB
IF Rejection (98MHz)	90dB
Spurious Rejection	75dB
AM Suppression	50dB
Harmonic Distortion: MONO	Less than 0.2%
STEREO	Less than 0.4%
Frequency Response 20Hz~15kHz	± 0.2 dB
50Hz~10kHz	± 0.3 dB
Frequency Response 1kHz	More than 40dB
50Hz~10kHz	More than 30dB
Sub Carrier Suppression	40dB
Antenna Input	300Ω Balanced 75Ω Unbalanced
Muting	ON-OFF

AM Section

Sensitivity (IHF, Ferrite antenna)	300μV/m
(IHF, Ext. antenna)	15μV
Selectivity	35dB
Signal-to-Noise Ratio	50dB
Image Rejection	40dB
IF Rejection	70dB

Miscellaneous

Power Requirements	AC 120V 60Hz, 220V 50/60Hz or 110, 120, 130, 220 and 240V (switchable) 50/60Hz
Power Consumption	130W (UL approved model only) 180W (Others model)
Dimensions	480 (W) x 147 (H) x 405 (D) mm 18-7/8 x 5-13/16 x 15-15/16 in.
Weight:	Without Package 10.3kg (22 lb 8 oz) With Package 12.1kg (26 lb 7 oz)

Furnished Parts

FM T-type Antenna	1
Operating Instructions	1
Fuse 3A	1
Fuse 1.5A	1 (5 line voltage model only)

NOTE:

Specifications and the design subject to possible modification without notice due to improvements.

MOUNTING TEMPLATE

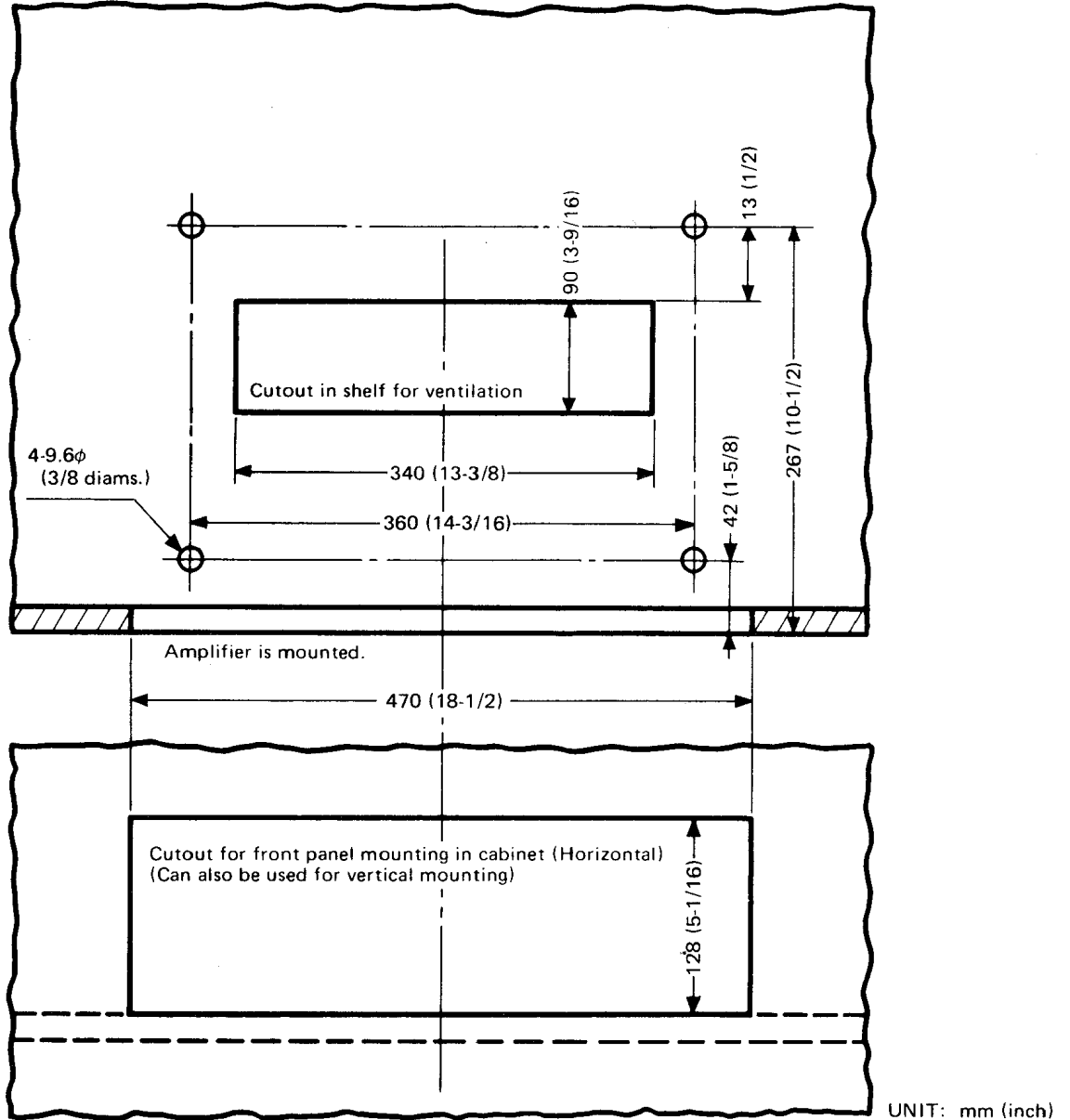

Remove the four feet on the bottom plate of the unit.
 After removing feet, fasten setscrews into holes from which feet were removed.

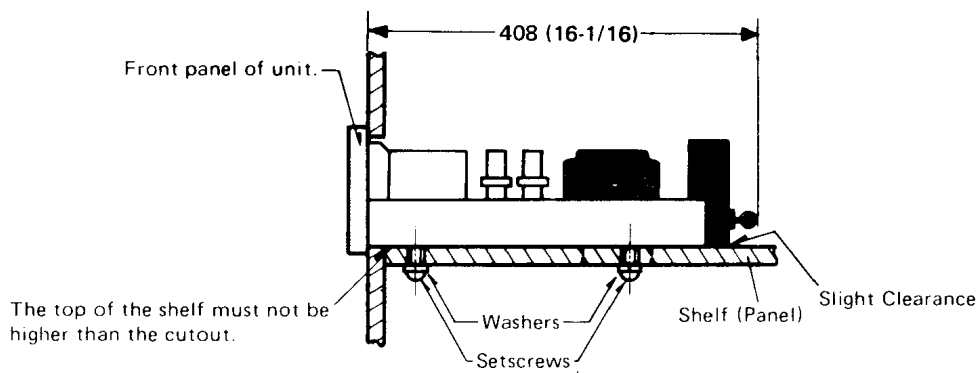

Use M4 (ISO) setscrews of within 10mm (1/3") long for combining amp's bottom plate with any panel, allowing a slight clearance.

